

LV-675

Mini-ITX Motherboard

User's Manual

Edition 1.0
2005/11/30



Copyright

Copyright 2005, all rights reserved. This document is copyrighted and all rights are reserved. The information in this document is subject to change without prior notice to make improvements to the products.

This document contains proprietary information and protected by copyright. No part of this document may be reproduced, copied, or translated in any form or any means without prior written permission of the manufacturer.

All trademarks and/or registered trademarks contains in this document are property of their respective owners.

Disclaimer

The company shall not be liable for any incidental or consequential damages resulting from the performance or use of this product.

The company does not issue a warranty of any kind, express or implied, including without limitation implied warranties of merchantability or fitness for a particular purpose. The company has the right to revise the manual or include changes in the specifications of the product described within it at any time without notice and without obligation to notify any person of such revision or changes.

Trademark

All trademarks are the property of their respective holders.

Any questions please visit our website at <http://www.commell.com.tw>

Packing List:

Please check the package content before you starting using the board.

Hardware:

LV-675 motherboard x 1

Cable Kit:

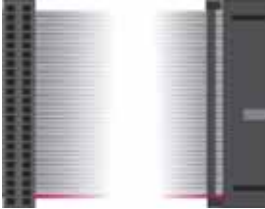

44-pin ATA33 IDE Cable x 1



26-pin Slim Type Floppy Cable x 1

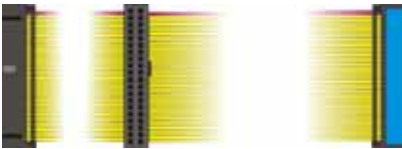

40-pin ATA100 IDE Cable x 1

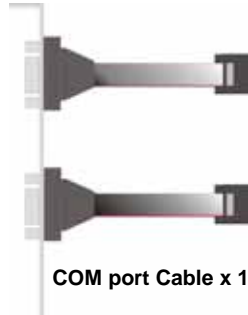

COM port Cable x 1

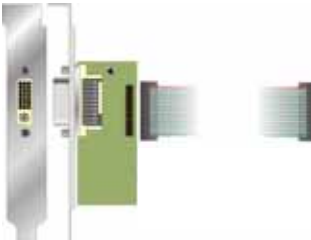

DVI output cable kit (LV-675D only)



CPU Cooler x 1



I/O Shield x 1

Printed Matters:

User's Manual x 1

Driver CD x 1

Index

Chapter 1 <Introduction>	7
1.1 <Product Overview>	7
1.2 <Product Specification>	8
1.3 <Mechanical Drawing>	10
1.4 <Block Diagram>	11
Chapter 2 <Hardware Setup>	13
2.1 <Connector Location>	13
2.2 <Jumper Location & Reference>	14
2.3 <Connector Reference>	15
2.3.1 <Internal Connectors>	15
2.3.2 <External Connectors>	15
2.4 <CPU and Memory Setup>	16
2.4.1 <CPU Setup>	16
2.4.2 <Memory Setup>	17
2.5 <CMOS Setup>	18
2.6 <IDE Interface >	19
2.7 <Enhanced IDE Interface>	20
2.8 <Floppy Port>	21
2.9 <Ethernet Interface>	22
2.10 <Onboard Display Interface>	23
2.10.1 <Analog Display>	23
2.10.2 <LVDS Display LV-675X Only>	24
2.10.3 <DVI Display LV-675D Only>	28
2.10.4 <S-Video Interface>	29
2.11 <Integrated Audio Interface>	30
2.12 <GPIO Interface>	32
2.13 <Power Supply>	33
2.13.1 <Power Input>	33
2.14 <Switch and Indicator>	34

Chapter 3 <System Setup>	35
3.1 <Video Memory Setup>	35
Chapter 4 <BIOS Setup>	36
Appendix A <I/O Port Pin Assignment>	38
A.1 <IDE Port>	38
A.2 <Floppy Port>	40
A.3 <IrDA Port>	40
A.4 <Serial Port>	41
A.5 <VGA Port>	41
A.6 <LAN Port>	41
A.7 < USB Interface >	42
A.8 < LPT Port >	42
Appendix B <Flash BIOS>	43
B.1 <Flash Tool>	43
B.2 <Flash BIOS Procedure>	43
Appendix C <System Resources>	44
C.1<I/O Port Address Map>	44
C.2<Memory Address Map>	46
C.3<System IRQ & DMA Resources>	47
Appendix D <Display Setting>	49
Appendix E <How to choose RS-422&RS-485>	51
Appendix F<Programming Watch dog Timer>	52
Contact Information	53

(This Page is Left for Blank)

Chapter 1 <Introduction>

1.1 <Product Overview>

LV-675 is the new generation of the Mini-ITX motherboard, with supporting last Intel Pentium M processors for 533/400MHz front side bus, Intel 845GV and ICH4 chipset, integrated graphics, DDR200/266/333 memory, REALTEK ALC 655 High Definition Audio, and one Intel 82541PI Gigabit LAN.

New Intel Pentium M Processor

The board supports last Intel Pentium M processors with 400/533MHz front side bus, to provide more powerful performance than before.

New features for Intel 845GV chipset

The board integrates Intel 845GV and ICH4 chipset, to provide new generation of the mobile solution, supports Intel graphics, DDR 200/266/333MHz memory, High Definition Audio with 5.1 channels surrounding sound.

All in One multimedia solution

Based on Intel 845GV and ICH4 chipset, the board provides high performance onboard graphics, 18/24-bit dual channel LVDS interface(LV-675X only),DVI interface(LV-675D only), S-Video, TV-out and REALTEK ALC 655 5.1 channels High Definition Audio, to meet the very requirement of the multimedia application.

Flexible Extension Interface

The board provides one PCI-slot for graphics card, it also can support PCI-slot for LAN card or other devices. The board also provides two mini-PCI socket.

1.2 <Product Specification>

General Specification

Form Factor	Mini-ITX motherboard
CPU	Intel® Pentium M / Celeron M processors Package type: FC-PGA478 Front side bus: 400/533MHz
Memory	1 x 184-pin DDR 200/266/333MHz SDRAM up to 1GB Unbuffered, none-ECC memory supported only
Chipset	Intel® 845GV (Northbridge) and ICH4 (Southbridge)
BIOS	Phoenix-Award v6.00PG 4Mb PnP flash BIOS
Green Function	Power saving mode includes doze, standby and suspend modes. ACPI version 1.0 and APM version 1.2 compliant
Watchdog Timer	System reset programmable watchdog timer with 1 ~ 255 sec./min. of timeout value
Real Time Clock	Intel® ICH4 built-in RTC with lithium battery
Enhanced IDE	UltraDMA100 40-pin IDE interface supports up to 2 ATAPI devices One 44-pin IDE port onboard

Multi-I/O Port

Chipset	Intel® ICH4 with Winbond® W83627HF controller
Serial Port	1x RS232 Port, 1x RS232/422/485 Port
USB Port	Four Hi-Speed USB 2.0 ports with 480Mbps of transfer rate
Parallel Port	One external bi-direction parallel port with SPP/ECP/EPP mode
Floppy Port	One slim type Floppy port
IrDA Port	One IrDA compliant Infrared interface supports SIR
K/B & Mouse	External PS/2 keyboard and mouse ports on rear I/O panel
GPIO	One 12-pin Digital I/O connector with 8-bit programmable I/O interface

VGA Display Interface

Chipset	Intel® 845GV GMCH (Graphic Memory Controller Hub)
Frame Buffer	Up to 64MB shared with system memory
Display Type	CRT, LCD monitor with analog display Onboard 18/24-bit dual channel LVDS interface (LV-675X Only) Onboard DVI interface(LV-675D Only)
Connector	External DB15 female connector on rear I/O panel Onboard 40-pin LVDS connector(LV-675X Only) Onboard 26-pin DVI Connector (LV-675D Only)

TV-Out interface

Chipset	Intel 845GV GMCH built-in Intel Extreme Graphics with Chrontel CH7009/CH7017 TV-out encoder
TV Mode	Support both of NTSC and PAL mode
Connector	External S-video and RCA Jack on rear I/O panel

Ethernet Interface

Controller	Intel 82541PI Gigabit Ethernet controller
Type	Triple speed 10/100/1000Base-T Auto-switching Fast Ethernet Full duplex, IEEE802.3U compliant
Connector	One External RJ45 connectors with LED on rear I/O panel

Audio Interface

Chipset	Intel ICH4 with REALTEK ALC655 AC97 3D audio codec
Interface	5.1 channel 3D audio with front (R/L), rear (R/L), center and bass SPDIF digital audio encoding signal input and output Line-in, line-out, CD-in and Mic-in
Connector	External three phone jack for 5.1 channel audio on rear panel External SPDIF connector on rear panel Internal 10-pin header for line-in/-out, Mic-out, 4-pin header for CD-in

Expansive Interface

PCI	One onboard standard PCI Slot(32-bit,33MHz) Two Mini-PCI socket for TYPE III (32-bit, 33MHz) Power supply: +3.3V, +5V
-----	--

Power and Environment

Power Requirement	Standard ATX Power Supply
Dimension	170 (L) x 170 (H) mm
Temperature	Operating within 0 ~ 60°C (32 ~ 140°F) Storage within -20 ~ 85°C (-4 ~ 185°F)

Ordering Code

LV-675X	Intel Pentium M Mini-ITX motherboard with onboard VGA, 1 x Gigabit LAN, 4 x USB 2.0 Ports, Audio, 1 x RS232, 1 x RS232/422/485, LVDS, S-Video, 1x PCI slot, 2 x Mini-PCI, 1 x Parallel Port, 1x SPDIF
LV-675D	Intel Pentium M Mini-ITX motherboard with onboard VGA, 1 x Gigabit LAN, 4 x USB 2.0 Ports, Audio, 1 x RS232, 1 x RS/232/422/485 , DVI, S-Video, 1x PCI slot, 2 x Mini-PCI, 1 x Parallel Port, 1x SPDIF
MP-878D	Mini-PCI Capture Card
MP-541D	Mini-PCI with one Giga Ethernet With Intel 82541PI PCI Connector
MP-541D2	Mini-PCI with two Giga Ethernet With Intel 82541PI PCI Connector

The specifications may be different as the actual production.

For further product information please visit the website at <http://www.commell.com.tw>

1.3 <Mechanical Drawing>

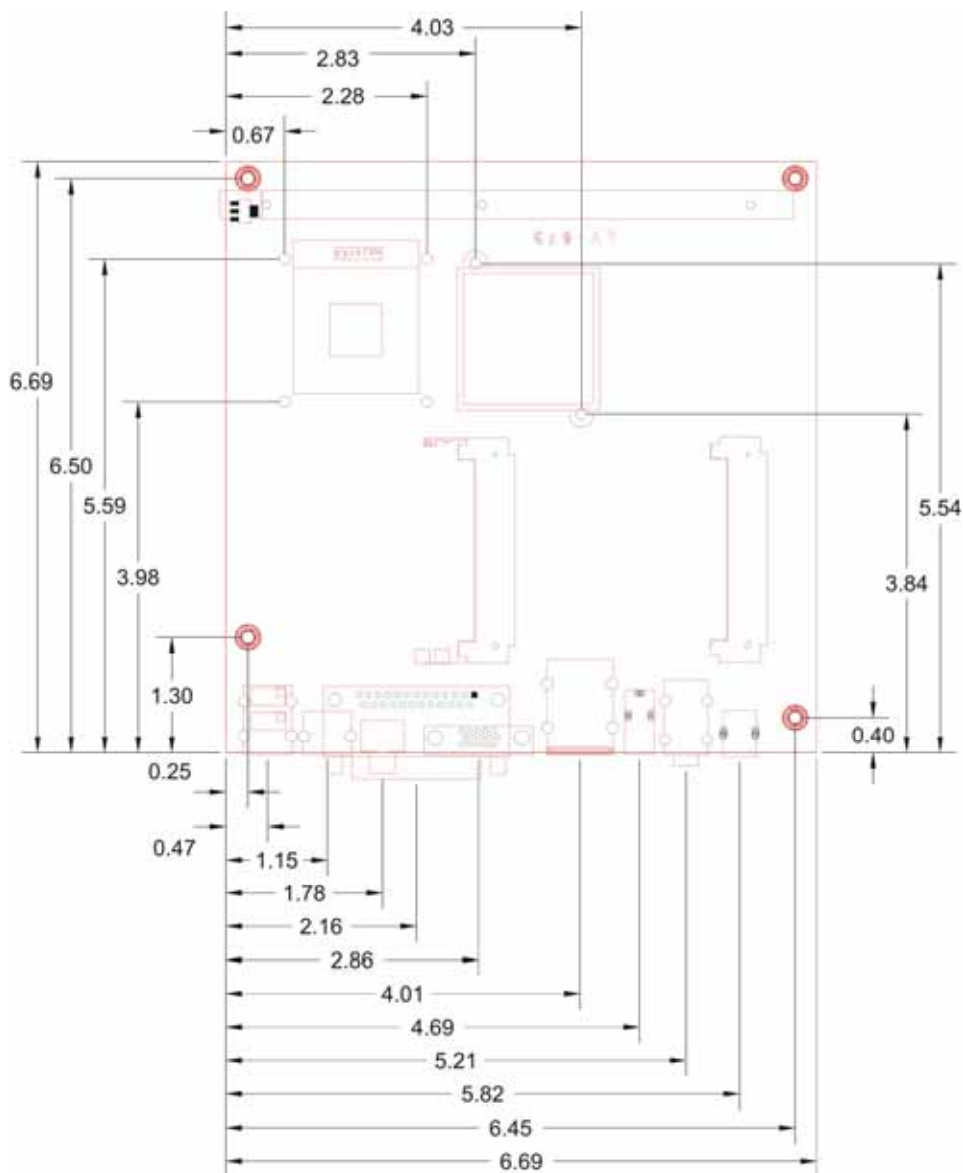

1.4 <Block Diagram>

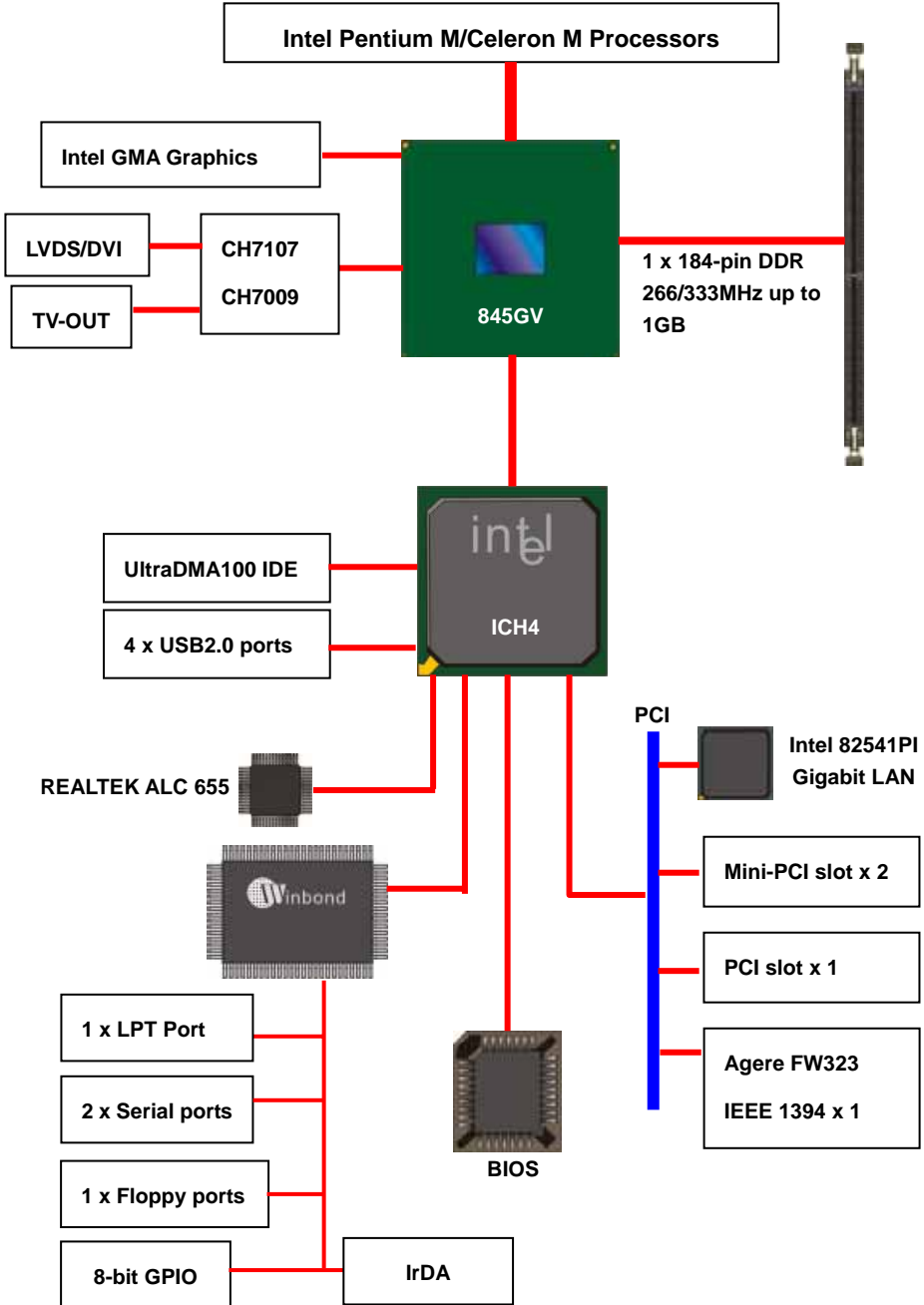

(This Page is Left for Blank)

Chapter 2 <Hardware Setup>

2.1 <Connector Location>

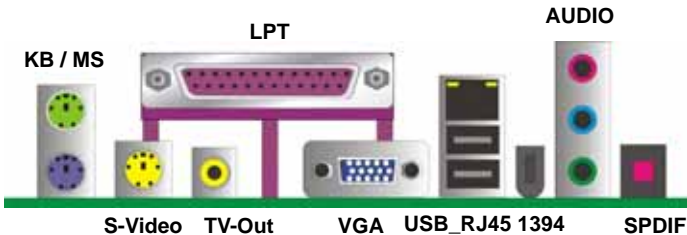
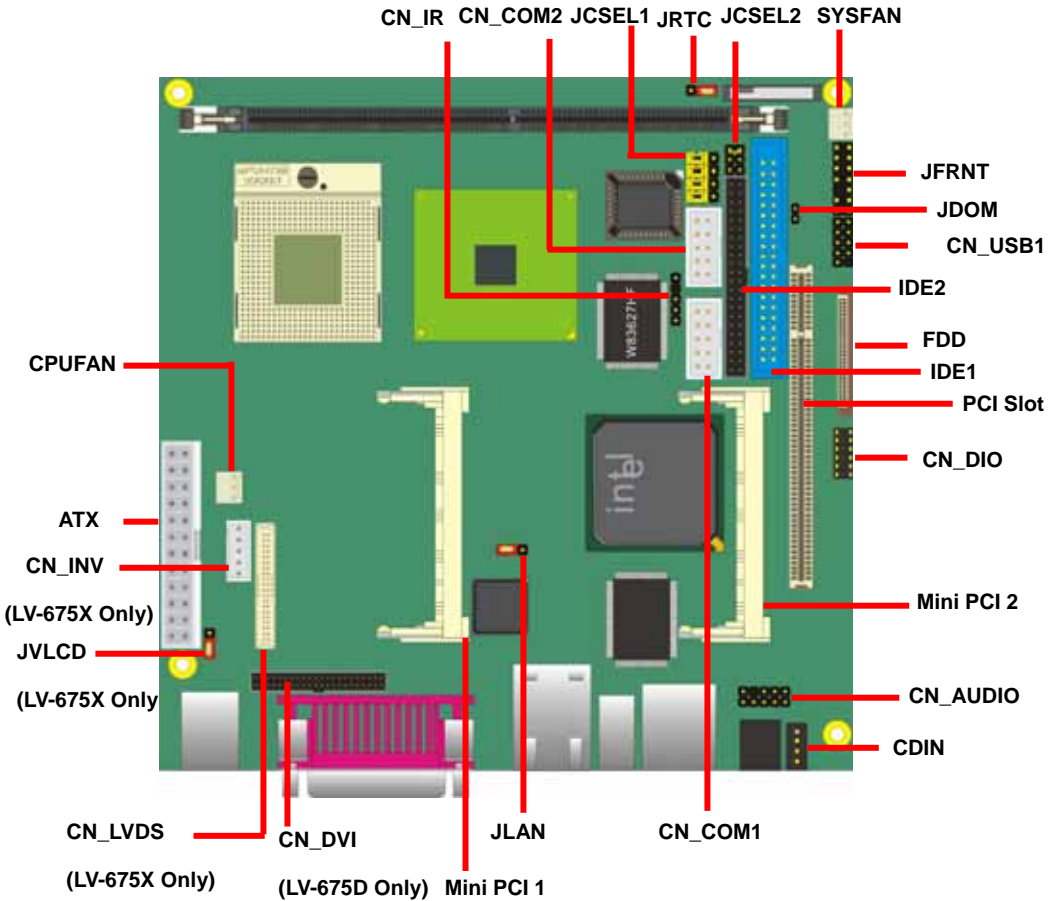

2.2 <Jumper Location & Reference>

Jumper	Function
JRTC	CMOS Operating/Clear Setting
JVLCD	Panel Voltage Setting (LV-675X Only)
JLAN	Enable/Disable on Board LAN function
JDOM	IDE1 Pin-20 voltage setting

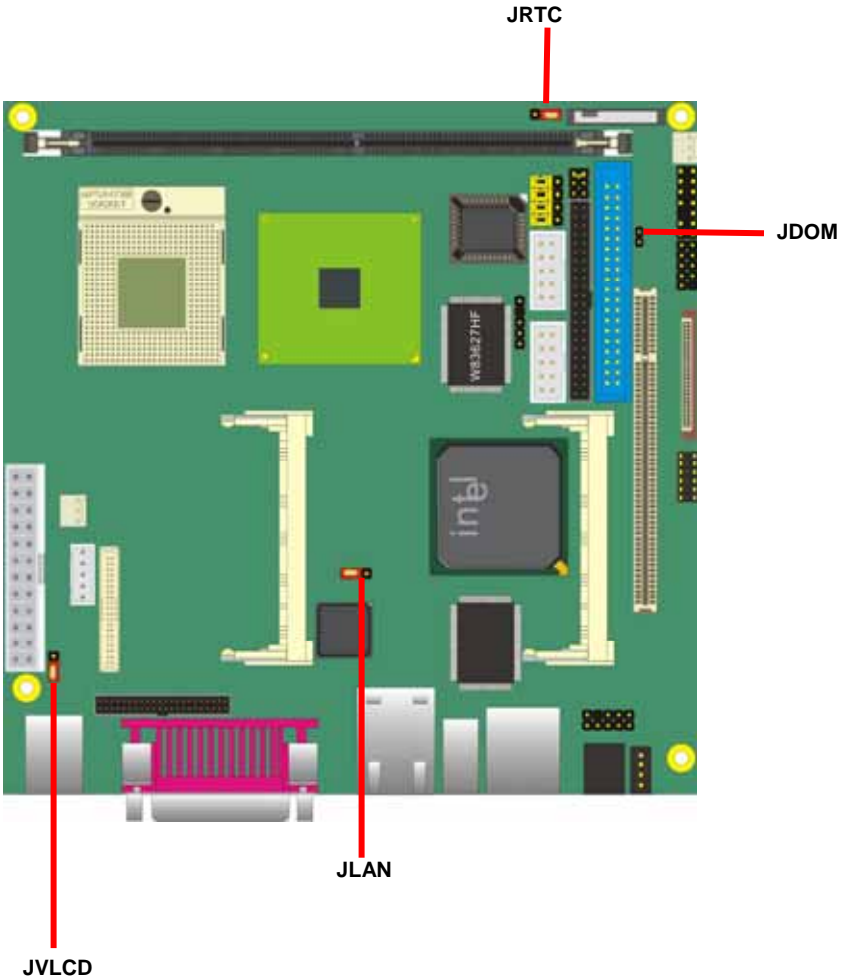

2.3 <Connector Reference>

2.3.1 <Internal Connectors>

Connector	Function	Remark
CPU	Socket478 for Intel Pentium M/Celeron M CPU	Standard
DIMM	184-pin DDR SDRAM DIMM socket	Standard
IDE1	40-pin IDE connector	Standard
IDE2	44-pin IDE connector	Slim
FDD	26-pin slim type floppy connector	Slim
ATX	24-pin ATX power input connector	Standard
CN_AUDIO	5 x 2-pin audio connector	Standard
CDIN	4-pin CD-ROM audio input connector	Standard
CN_DIO	6 x 2-pin digital I/O connector	Standard
CN_USB	5 x 2-pin USB connector	Standard
CPUFAN	3-pin CPU cooler fan connector	Standard
SYSFAN	3-pin system cooler fan connector	Standard
CN_LVDS	20 x 2-pin LVDS connector(LV-675X Only)	Standard
CN_INV	5-pin LCD inverter connector(LV-675X Only)	Standard
CN_IR	5-pin IrDA connector	Standard
CN_COM1/2	5 x 2-pin COM1 & COM2 connector	Standard
JFRNT	14-pin front panel switch/indicator connector	Standard
Mini-PCI	2 x Mini-PCI socket	Standard
CN_DVI	26-Pin connector(LV-675D Only)	Standard

2.3.2 <External Connectors>

Connector	Function	Remark
USB_RJ45	One USB and RJ45 LAN connector	Standard
VGA	DB15 analog VGA connector	Standard
KB	PS/2 keyboard connector	Standard
MS	PS/2 mouse connector	Standard
AUDIO	Audio connectors	Standard
SPDIF	SPDIF digital audio output connector	Standard
S-Video	S-video connector on rear I/O panel	Standard
TV-Out	RCA Jack on rear I/O panel	Standard
1394	One IEEE1394 connector on rear I/O panel	Standard
LPT	One parallel port on rear I/O panel	Standard

2.4 <CPU and Memory Setup>

2.4.1 <CPU Setup>

The board comes with the socket478 for Intel Pentium M/Celeron M processors, it supports new generation of Intel Pentium M processors with 400/533MHz of front side bus . Please follow the instruction to install the CPU properly.

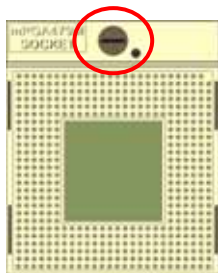

1. Use the flat-type screw drive to unlock the CPU socket



Unlock way

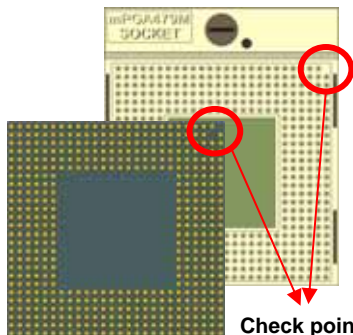

Check point

2. Follow the pin direction to install the processor on the socket



3. Lock the socket

2.4.2 <Memory Setup>

The board provides one 184-pin DDR DIMM to support DDR 200/266/333 memory modules up to 1GB of capacity. Non-ECC, unbuffered memory is supported only.

DDR

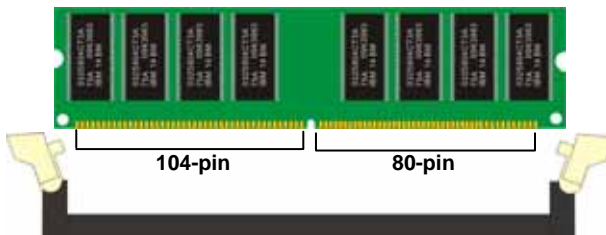
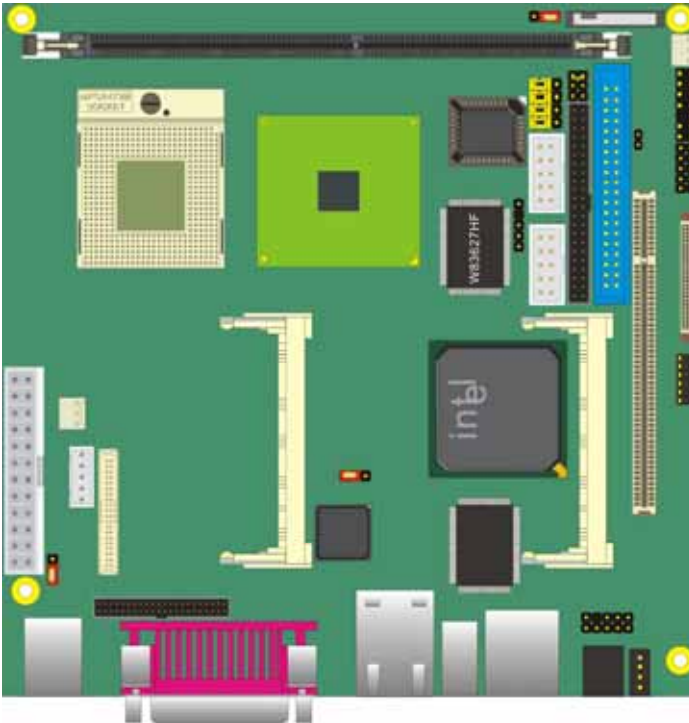

Please check the pin number to match the socket side well before installing memory module.

2.5 <CMOS Setup>

The board's data of CMOS can be setting in BIOS. If the board refuses to boot due to inappropriate CMOS settings, here is how to proceed to clear (reset) the CMOS to its default values.

Jumper: JRTC

Type: Onboard 3-pin jumper

JRTC	Mode
1-2	Clear CMOS
2-3	Normal Operation

Default setting

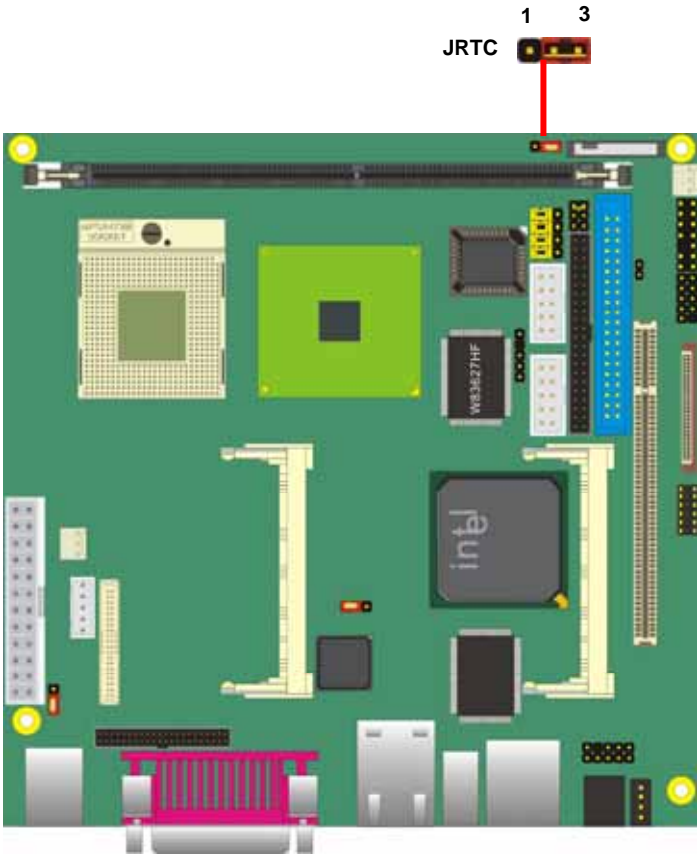

2.6 <IDE Interface>

The board has one UltraDMA100 IDE1 interface to support up to 2 ATAPI devices .

The board has one UltraDMA33 IDE2 interface to support up to 2 ATAPI devices .

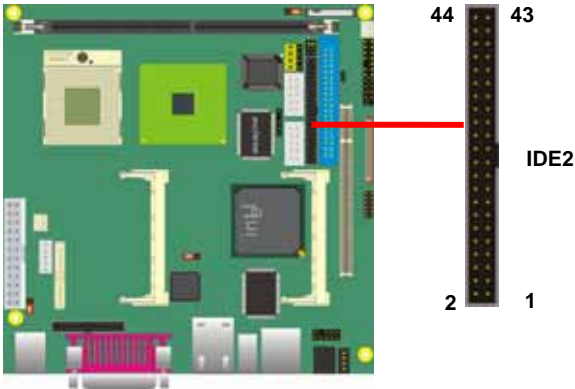
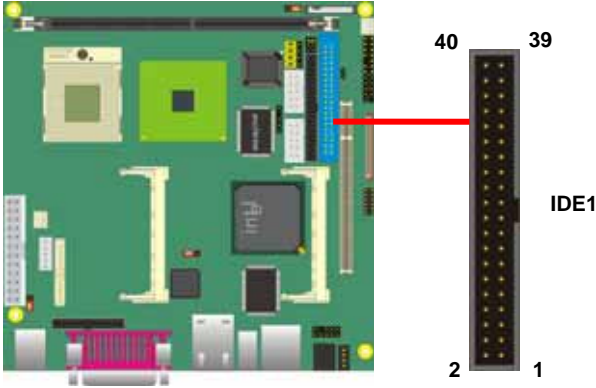

2.7 < Enhanced IDE Interface >

The Intel® ICH4 (south bridge chip) supports one enhanced IDE interface, dual channel for two ATAPI devices with ATA100. Based on this function, **LV-675** has one 40-pin IDE connector with jumper selectable for pin-20 +5V supported. The jumper **JDOM** is two-pin type for pin-20 supplied with +5V to apply the DOM (Disk on Module).

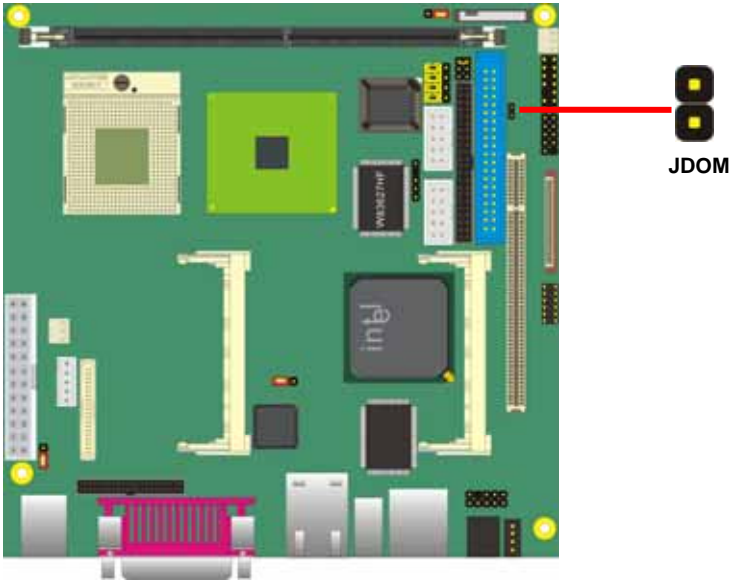

Jumper: **JDOM**

Type: onboard 2-pin header

JDOM	Mode
ON	IDE1 pin-20 5V power supply enable
OFF	No 5V power supply on IDE1 pin-20

Default setting

2.8 <Floppy Port>

The board provides one slim type floppy port.

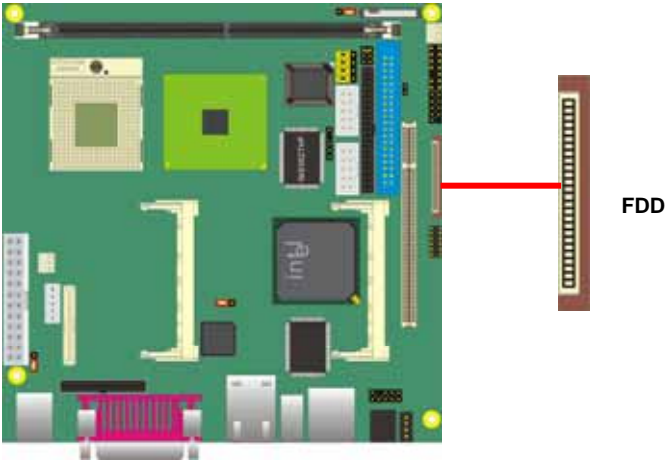

Floppy rear side

1. Lift up the brown plastic bar
2. Slot the cable in (Blue paste for brown bar side)
3. Press back the plastic bar

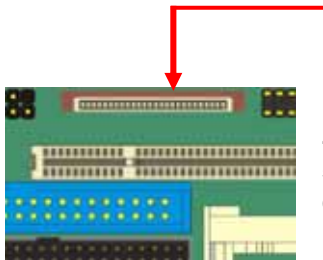

4. Lift up this plastic bar
5. Slot the cable in (Blue paste for outside)
6. Press back the plastic bar

2.9 <Ethernet Interface>

LV-675 integrates one Gigabit LAN interfaces with Intel 82541PI; it provide a standard IEEE 802.3 Ethernet interface for 1000BASE-T, 100BASE-TX and 10BASE-T applications. LV-675 provides one RJ45 connectors on the rear I/O panel. The **JLAN** can let you set to enable/disable the onboard LAN function.

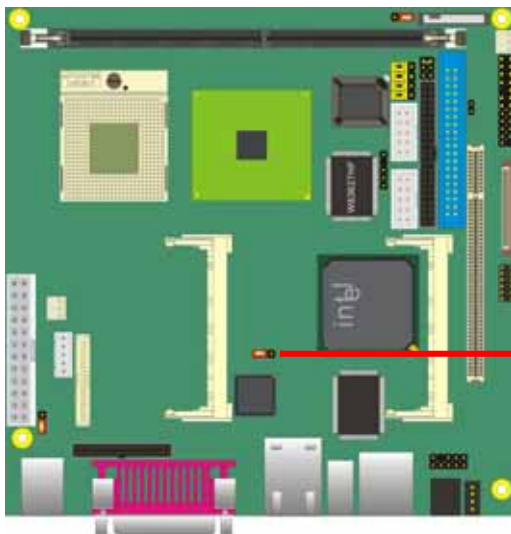

JLAN	Jump Setting
Enable	1-2 (Default)
Disable	2-3

JLAN

RJ45 LAN connector

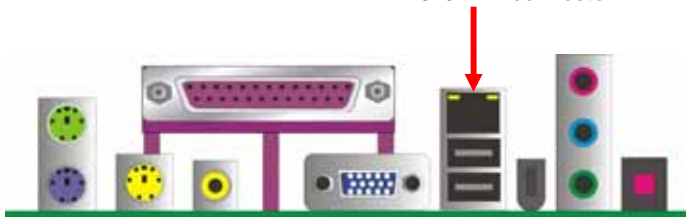

2.10 <Onboard Display Interface>

Based on Intel 845GV chipset with built-in graphics, the board provides one DB15 connector on rear external I/O port, and one 40-pin LVDS interface with 5-pin LCD backlight inverter connector(LV-675X Only). The board provides dual display function with clone mode and extended desktop mode for CRT and LCD.

Notice: When you install any PCI Graphic card, the onboard graphics would be disabled automatically.

2.10.1 <Analog Display>

Please connect your CRT or LCD monitor with DB15 male connector to the onboard DB15 female connector on rear I/O port.

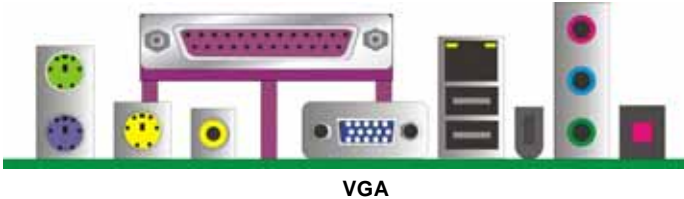

2.10.2 <LVDS Display LV-675X Only >

The board provides one 40-pin LVDS connector for 18/24-bit dual channel panels, supports up to 1600 x 1200 (UXGA) of resolution, with one LCD backlight inverter connector and one jumper for panel voltage setting.

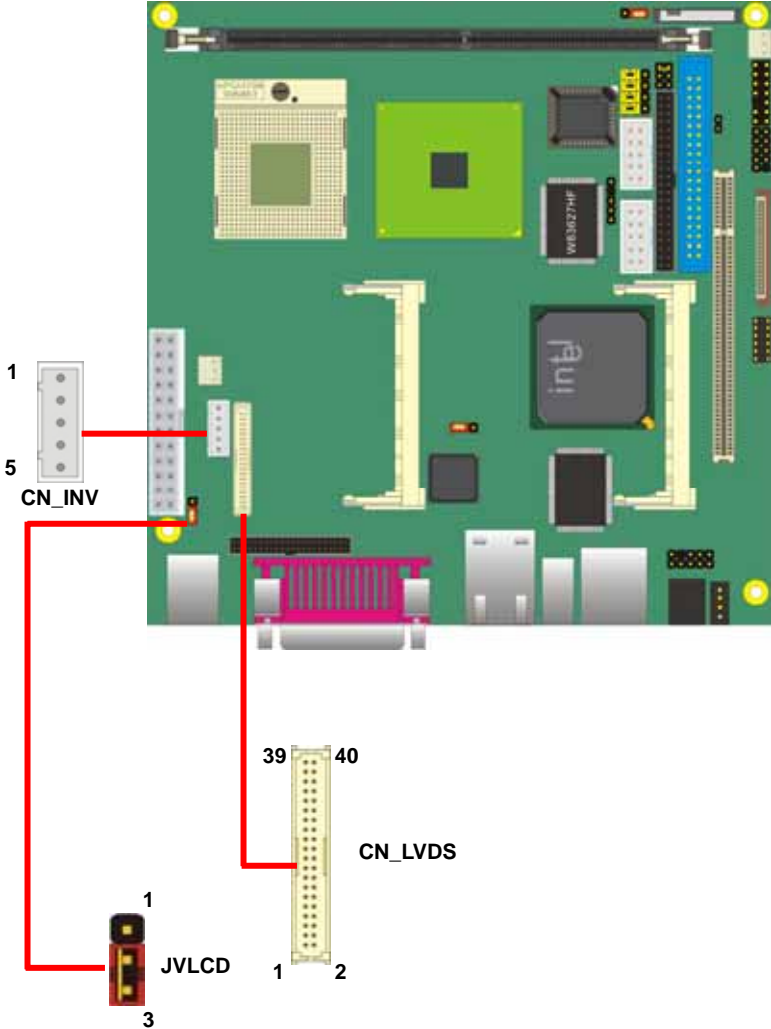

Connector: **CN_INV**

Type: 5-pin LVDS Power Header

Pin	Description
1	+12V
2	GND
3	GND
4	GND
5	ENABKL

Connector: **JVLCD**

Type: 3-pin Power select Header

Pin	Description
1	VCC (5V)
2	VCC/LDC
3	VCC3 (3.3)

Connector: **CN_LVDS**

Type: onboard 40-pin connector for LVDS connector

Connector model: **HIROSE DF13-40DP-1.25V**

Pin	Signal	Pin	Signal
2	LCDVCC	1	LCDVCC
4	GND	3	GND
6	ATX0+	5	BTX0+
8	ATX0-	7	BTX0-
10	GND	9	GND
12	ATX1+	11	BTX1+
14	ATX1-	13	BTX1-
16	GND	15	GND
18	ATX2+	17	BTX2+
20	ATX2-	19	BTX2-
22	GND	21	GND
24	ACLK+	23	BTX3+
26	ACLK-	25	BTX3-
28	GND	27	GND
30	ATX3+	29	BCLK+
32	ATX3-	31	BCLK-
34	GND	33	GND
36	N/C	35	N/C
38	N/C	37	N/C
40	N/C	39	N/C

LV-675 User's Manual

To setup the LCD, you need the component below:

1. A panel with LVDS interfaces.
2. An inverter for panel's backlight power.
3. A LCD cable and an inverter cable.

For the cables, please follow the pin assignment of the connector to make a cable, because every panel has its own pin assignment, so we do not provide a standard cable; please find a local cable manufacture to make cables.

LCD Installation Guide:

1. Preparing the **LV-675, LCD panel** and the **backlight inverter**.

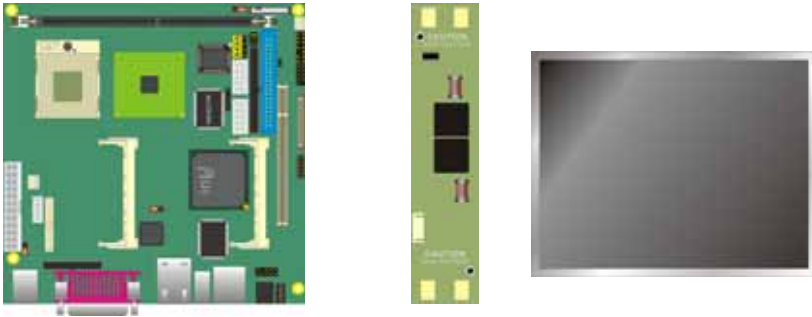

2. Please check the datasheet of the panel to see the voltage of the panel, and set the jumper **JVLCD** to +5V or +3.3V.
3. You would need a LVDS type cable.



4. To connect all of the devices well.

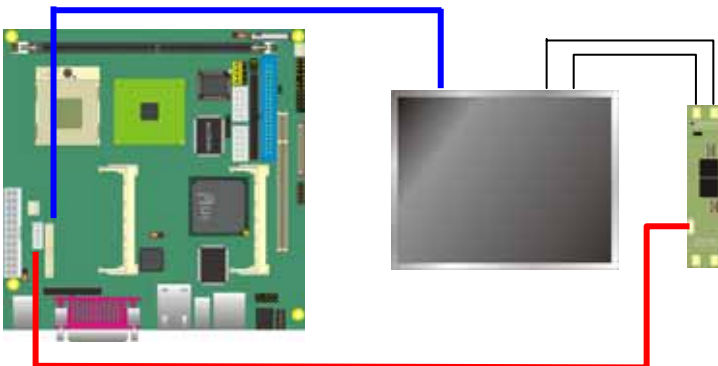

After setup the devices well, you need to select the LCD panel type in the BIOS.

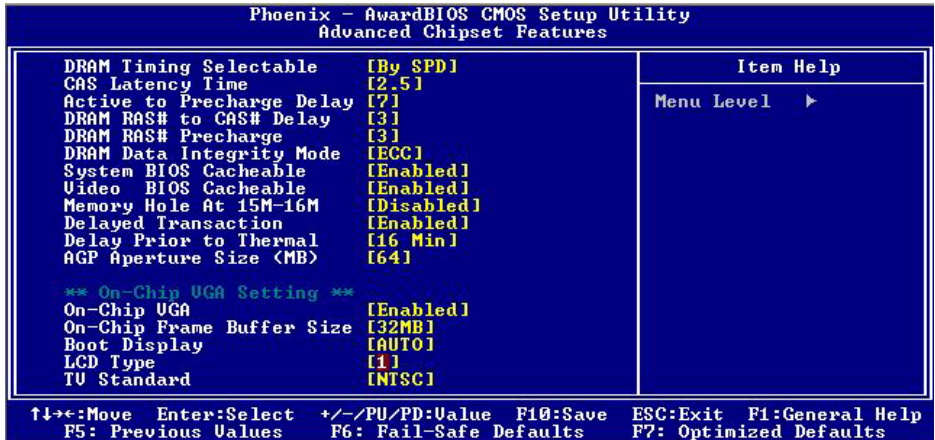

The panel type mapping is list below:

BIOS panel type selection form				
Single channel			Dual channel	
NO.	Output format		NO.	Output format
1	800 x 600 (18bit)		4	1280 x 1024 (24bit)
2	1024 x 768 (18bit)		5	1366 x 768 (24bit)
3	1024 x 768 (24bit)			

2.10.3 <DVI Display LV-675D Only >

The board provides optional DVI-D interface with Intel 845GV, compliant with DVI 1.0 standard, and supports dual display (clone or extended desktop) function with CRT.

Connector: **CN_DVI**

Connector type: 26-pin header connector (pitch = 2.54mm)

Pin Number	Assignment	Pin Number	Assignment
1	TX1+	2	TX1-
3	Ground	4	Ground
5	TXC+	6	TXC-
7	Ground	8	PVDD
9	N/C	10	N/C
11	TX2+	12	TX2-
13	Ground	14	Ground
15	TX0+	16	TX0-
17	N/C	18	HPDET
19	DDCDATA	20	DDCCLK
21	GND	22	N/C
23	N/C	24	N/C
25	N/C	26	N/C

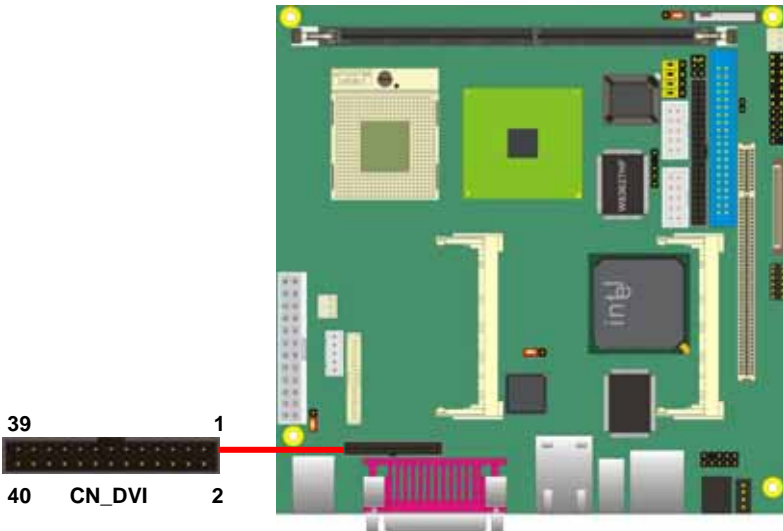

12.10.4 <S-Video Interface>

The board provides one S-Video interface up to 1024 x 768 resolution by NTSC/PAL supported, for three output types with Composite, S-Video and Component .

Notice1: This connector is for both S-Video/Composite outputs; please use attached two cables in the package for SDTV devices.

Notice2: S-Video and Composite can not be used at the same time.



S-Video TV-Out

2.11 <Integrated Audio Interface>

LV-675 integrated with REALTEK® ALC655 Codec for 5.1 channel sound output. It supports 16-bit stereo full-duplex with 48 KHz sampling rate, compliant with AC97 Rev.2.3 specifications.

The board has one phone jack on rear I/O panel for Line-out, Line-in, MIC(stereo)-in as 2-channel sound system, and Front, Rear, Center as 5.1-channel sound system. It also has one 10-pin header for additional audio output, the cable with phone jack is optional available.

For advanced configuration with system, please check the chapter of audio configuration.

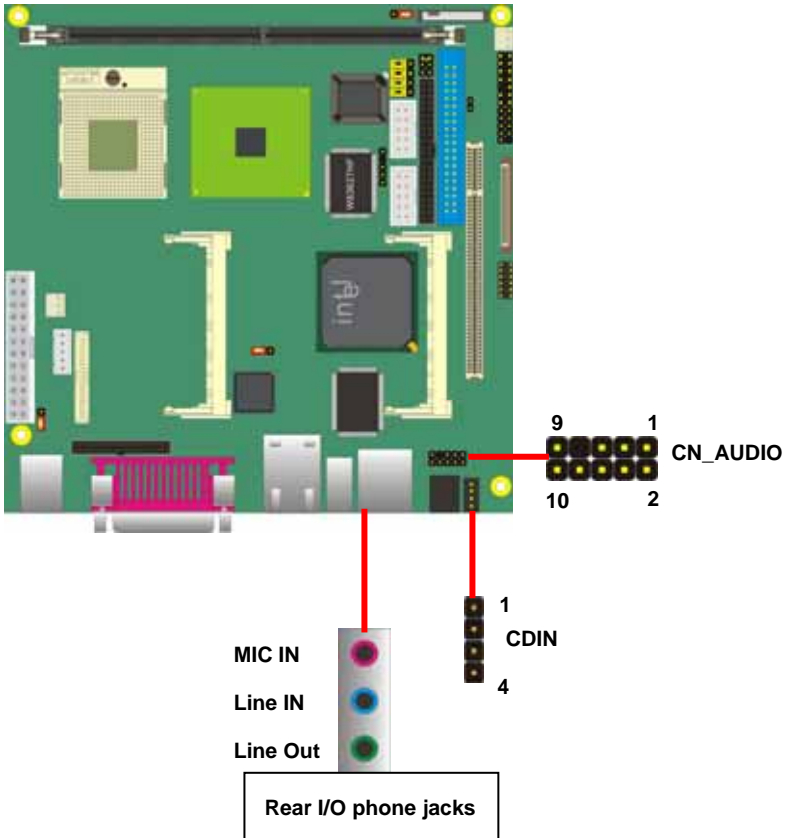

Connector: CN_AUDIO

Type: 10-pin (2 x 5) 1.27mm x 2.54mm-pitch header

Pin	Description	Pin	Description
1	Line in _L	2	Ground
3	Line in _R	4	MIC1
5	MIC2	6	Ground
7	N/C	8	Front_L
9	Front_R	10	Ground

Connector: CDIN

Type: 4-pin header (pitch = 2.54mm)

Pin	Description
1	CD – Left
2	Ground
3	Ground
4	CD – Right

2.12 <GPIO Interface>

The board provides a programmable 8-bit digital I/O interface; you can use this general purpose I/O port for system control like POS or KIOSK.

Connector: **CN_DIO**

Type: 12-pin (6 x 2) 2.0mm pitch header

Pin	Description	Pin	Description
1	Ground	2	Ground
3	GP0	4	GP4
5	GP1	6	GP5
7	GP2	8	GP6
9	GP3	10	GP7
11	VCC	12	+12V

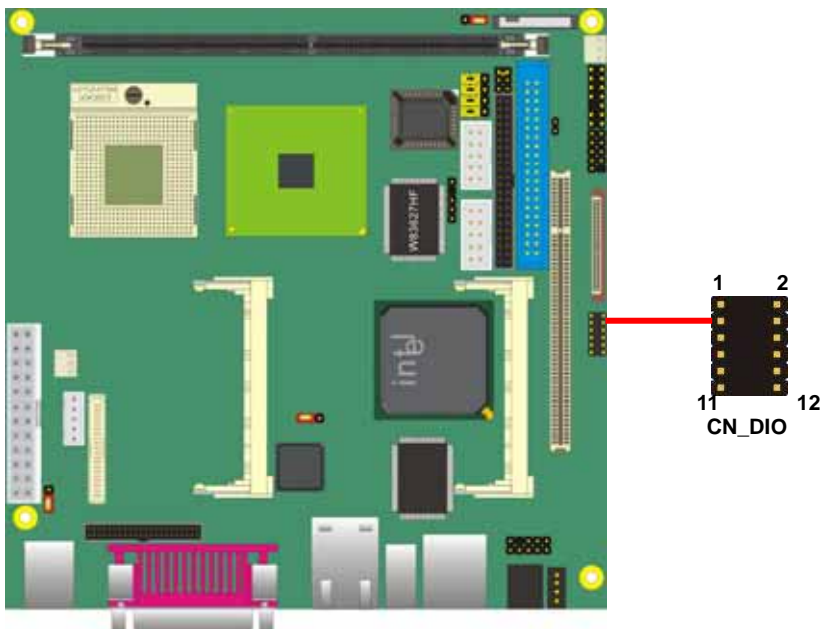

2.13 <Power Supply>

2.13.1 <Power Input>

The LV-675 provides a standard ATX power supply with **24-pin** ATX connector .

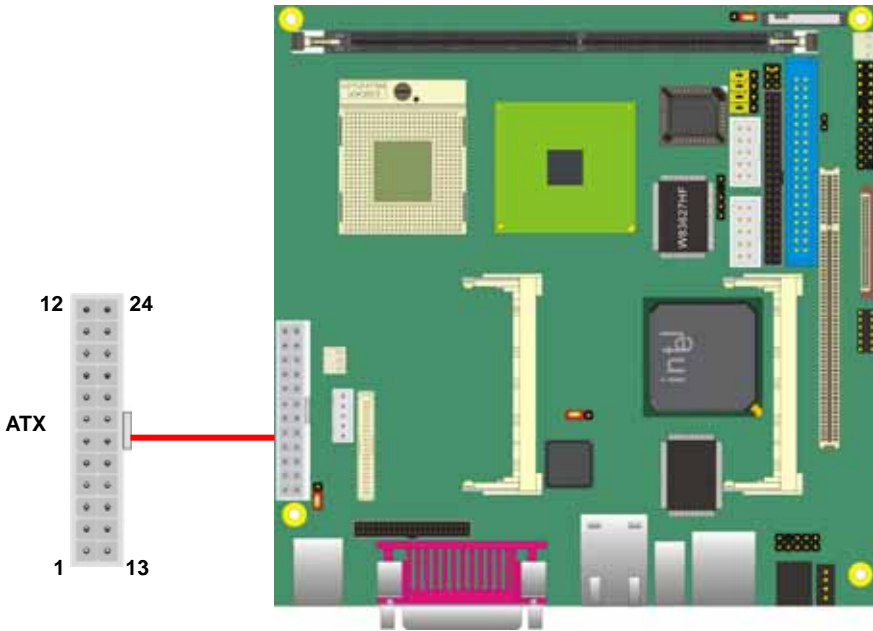

Connector: **ATX**

Type: 24-pin ATX power connector

PIN assignment			
1	3.3V	13	3.3V
2	3.3V	14	-12V
3	GND	15	GND
4	5V	16	PS_ON
5	GND	17	GND
6	5V	18	GND
7	GND	19	GND
8	PW_OK	20	-5V
9	5V_SB	21	5V
10	12V	22	5V
11	12V	23	5V
12	3.3V	24	GND

2.14 <Switch and Indicator>

The **JFRNT** provides front control panel of the board, such as power button, reset and beeper, etc. Please check well before you connecting the cables on the chassis.

Connector: **JFRNT**

Type: onboard 14-pin (2 x 7) 2.54-pitch header

Function	Signal	PIN		Signal	Function
IDE LED	HDLED+	1	2	PWRLED+	Power LED
	HDLED-	3	4	N/C	
Reset	Reset+	5	6	PWRLED-	Speaker
	Reset-	7	8	SPK+	
N/C		9	10	N/C	
Power Button	PWRBT+	11	12	N/C	
	PWRBT-	13	14	SPK-	

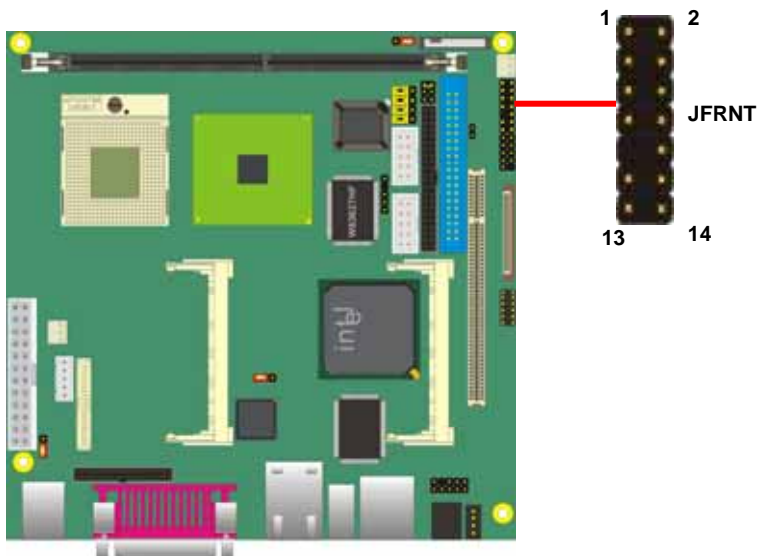

Chapter 3 <System Setup>

3.1 <Video Memory Setup>

Based on Intel® 845GV chipset , the board supports Intel® DVMT (Dynamic Video Memory Technology) 3.0, which would allow the video memory to be allocated up to 64MB.

To support DVMT, you need to install the Intel GMA Driver with supported OS.

BIOS Setup:

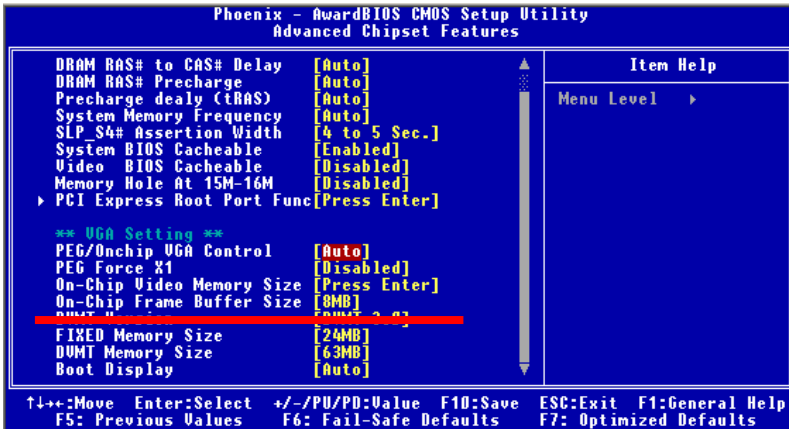

On-Chip Video Memory Size: This option combines three items below for setup.

On-Chip Frame Buffer Size:

This item can let you select video memory which been allocated for legacy VGA and SVGA graphics support and compatibility. The available option is **1MB** and **8MB**.

Fixed Memory Size:

This item can let you select a static amount of page-locked graphics memory which will be allocated during driver initialization. Once you select the memory amount, it will be no longer available for system memory.

Chapter 4 <BIOS Setup>

The motherboard uses the Award BIOS for the system configuration. The Award BIOS in the single board computer is a customized version of the industrial standard BIOS for IBM PC AT-compatible computers. It supports Intel x86 and compatible CPU architecture based processors and computers. The BIOS provides critical low-level support for the system central processing, memory and I/O sub-systems.

The BIOS setup program of the single board computer let the customers modify the basic configuration setting. The settings are stored in a dedicated battery-backed memory, NVRAM, retains the information when the power is turned off. If the battery runs out of the power, then the settings of BIOS will come back to the default setting.

The BIOS section of the manual is subject to change without notice and is provided here for reference purpose only. The settings and configurations of the BIOS are current at the time of print, and therefore they may not be exactly the same as that displayed on your screen.

To activate CMOS Setup program, press key immediately after you turn on the system. The following message "Press DEL to enter SETUP" should appear in the lower left hand corner of your screen. When you enter the CMOS Setup Utility, the Main Menu will be displayed as **Figure 4-1**. You can use arrow keys to select your function, press <Enter> key to accept the selection and enter the sub-menu.

Figure 4-1 CMOS Setup Utility Main Screen

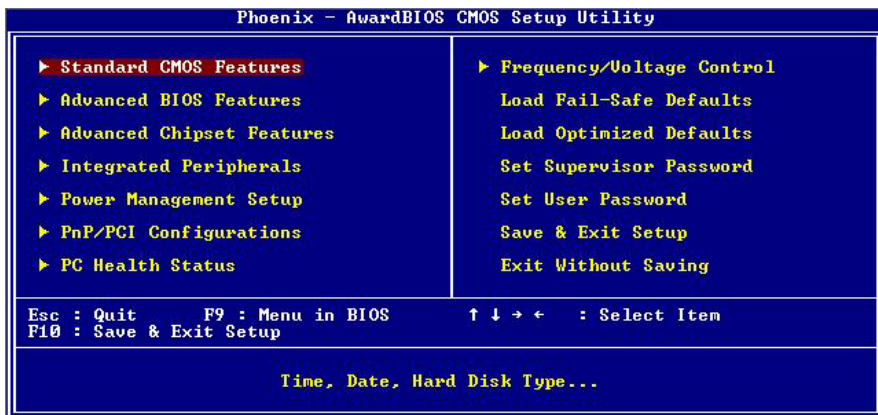

(This Page is Left for Blank)

Appendix A <I/O Port Pin Assignment>

A.1 <IDE Port>

Connector: **IDE1**

Type: 40-pin (20 x 2) box header

Pin	Description	Pin	Description
1	Reset	2	Ground
3	D7	4	D8
5	D6	6	D9
7	D5	8	D10
9	D4	10	D11
11	D3	12	D12
13	D2	14	D13
15	D1	16	D14
17	D0	18	D15
19	Ground	20	VCC
21	REQ	22	Ground
23	IOW-/STOP	24	Ground
25	IOR-/HDMARDY	26	Ground
27	IRDY/DDMARDY	28	IDESEL
29	DACK-	30	Ground
31	IRQ	32	N/C
33	A1	34	P66DET
35	A0	36	A2
37	CS0 (MASTER CS)	38	CS1 (SLAVE CS)
39	LED ACT-	40	Ground

Connector: IDE2

Type: 44-pin (22 x 2) box header

Pin	Description	Pin	Description
1	Reset	2	Ground
3	D7	4	D8
5	D6	6	D9
7	D5	8	D10
9	D4	10	D11
11	D3	12	D12
13	D2	14	D13
15	D1	16	D14
17	D0	18	D15
19	Ground	20	N/C
21	REQ	22	Ground
23	-IOW	24	Ground
25	-IOR	26	Ground
27	IORDY	28	IDSEL
29	DACK	30	Ground
31	IDEIRQ	32	IDE32
33	A1	34	P66DET
35	A0	36	A2
37	-CS1	38	-CS3
39	-HD LED1	40	Ground
41	+5V	42	+5V
43	Ground	44	Ground

A.2 <Floppy Port>

Connector: **FDD**

Type: 26-pin connector



Pin	Description	Pin	Description
1	VCC	2	INDEX
3	VCC	4	DR0
5	VCC	6	DSKCH
7	N/C	8	N/C
9	N/C	10	MTR0
11	DRVDE0	12	DIR
13	N/C	14	STEP
15	Ground	16	WRITE DATA
17	Ground	18	WRITE GATE
19	Ground	20	TRACK 0
21	N/C	22	WRPRO
23	Ground	24	RDATA-
25	Ground	26	SEL

A.3 <IrDA Port>

Connector: **CN_IR**

Type: 5-pin header for SIR Ports

Pin	Description
1	VCC
2	N/C
3	IRRX
4	Ground
5	IRTX



A.4 <Serial Port>

Connector: **COM1/COM2**

Type: 9-pin D-sub male connector on bracket



Pin	Description	Pin	Description
1	DCD-	6	DSR-
2	SIN-	7	RTS-
3	SO-	8	CTS-
4	DTR-	9	RI
5	Ground		

A.5 <VGA Port>

Connector: **VGA**

Type: 15-pin D-sub female connector on bracket

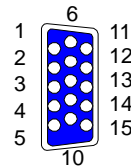

Pin	Description	Pin	Description	Pin	Description
1	RED	6	Ground	11	N/C
2	GREEN	7	Ground	12	+5V
3	BLUE	8	Ground	13	5HSYNC
4	N/C	9	N/C	14	5VSYNC
5	-CRTATCH	10	Ground	15	5VCLK

A.6 <LAN Port>

Connector: **RJ45**

Type: RJ45 connector with LED on bracket



Pin	1	2	3	4	5
Description	TRD0+	TRD0-	TRD1+	TRD1-	NC

Pin	6	7	8	9	10
Description	NC	TRD2+	TRD2-	TRD3+	TRD3-

A.7 < USB Interface >

Connector: **CN_USB**

Type: 10-pin (5 x 2) header for dual USB Ports

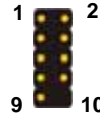

Pin	Description	Pin	Description
1	VCC	2	VCC
3	Data0-	4	Data1-
5	Data0+	6	Data1+
7	Ground	8	Ground
9	Ground	10	NC

A.8 < LPT Port >



Connector : **LPT**

Type :26-Pin D-Sub female Connector on bracket

Pin	Description	Pin	Description
1	-PSTB	2	PRO0
3	PRO1	4	PRO2
5	PRO3	6	PRO4
7	PRO5	8	PRO6
9	PRO7	10	ACK-
11	BUSY	12	PE
13	SLCT	14	AFD-
15	ERR-	16	INT-
17	SLIN-	18	Ground
19	Ground	20	I/O Ground
21	Ground	22	Ground
23	Ground	24	Ground
25	Ground	26	Ground

Appendix B <Flash BIOS>

B.1 <Flash Tool>

The board is based on Award BIOS and can be updated easily by the BIOS auto flash tool. You can download the tool online at the address below:

<http://www.phoenix.com/en/home/>

http://www.commell.com.tw/Support/Support_SBC.htm

File name of the tool is "awdf flash.exe", it's the utility that can write the data into the BIOS flash chip and update the BIOS.

B.2 <Flash BIOS Procedure>

1. Please make a bootable floppy disk.
2. Get the last .bin files you want to update and copy it into the disk.
3. Copy awardflash.exe to the disk.
4. Power on the system and flash the BIOS. (Example: C:/ awardflash XXX.bin)
5. Restart the system.

Any question about the BIOS re-flash please contact your distributors or visit the web-site at below:

<http://www.commell.com.tw/support/support.htm>

Appendix C <System Resources>

C1.<I/O Port Address Map>

[00000000 - 0000000F]	Direct memory access controller
[00000000 - 00000CF7]	PCI bus
[00000010 - 0000001F]	Motherboard resources
[00000020 - 00000021]	Programmable interrupt controller
[00000022 - 0000003F]	Motherboard resources
[00000040 - 00000043]	System timer
[00000044 - 0000005F]	Motherboard resources
[00000060 - 00000060]	Standard 101/102-Key or Microsoft Natural PS/2 Keyboard
[00000061 - 00000061]	System speaker
[00000062 - 00000063]	Motherboard resources
[00000064 - 00000064]	Standard 101/102-Key or Microsoft Natural PS/2 Keyboard
[00000065 - 0000006F]	Motherboard resources
[00000070 - 00000073]	System CMOS/real time clock
[00000074 - 0000007F]	Motherboard resources
[00000080 - 00000090]	Direct memory access controller
[00000091 - 00000093]	Motherboard resources
[00000094 - 0000009F]	Direct memory access controller
[000000A0 - 000000A1]	Programmable interrupt controller
[000000A2 - 000000BF]	Motherboard resources
[000000C0 - 000000DF]	Direct memory access controller
[000000E0 - 000000EF]	Motherboard resources
[000000F0 - 000000FF]	Numeric data processor
[00000170 - 00000177]	Secondary IDE Channel
[000001F0 - 000001F7]	Primary IDE Channel
[00000274 - 00000277]	ISAPNP Read Data Port
[00000279 - 00000279]	ISAPNP Read Data Port
[00000294 - 00000297]	Motherboard resources
[000002F8 - 000002FF]	Communications Port (COM2)
[00000376 - 00000376]	Secondary IDE Channel
[00000378 - 0000037F]	Printer Port (LPT1)
[000003B0 - 000003BB]	Intel(R) 82845G/GL/GE/PE/GV Graphics Controller
[000003C0 - 000003DF]	Intel(R) 82845G/GL/GE/PE/GV Graphics Controller
[000003F0 - 000003F5]	Standard floppy disk controller
[000003F6 - 000003F6]	Primary IDE Channel
[000003F7 - 000003F7]	Standard Floppy disk controller
[000003F8 - 000003FF]	Communications Port (COM1)
[00000400 - 000004BF]	Motherboard resources
[000004D0 - 000004D1]	Motherboard resources
[00000500 - 0000051F]	Intel(R) 82801DB/DBM SMBus Controller - 24C3

[00000778 - 0000077B] Printer Port (LPT1)
[00000A78 - 00000A7B] Motherboard resources
[00000B78 - 00000B7B] Motherboard resources
[00000BBC - 00000BBF] Motherboard resources
[00000D00 - 0000FFFF] PCI bus
[00000E78 - 00000E7B] Motherboard resources
[00000F78 - 00000F7B] Motherboard resources
[00000FBC - 00000FBF] Motherboard resources
[0000D000 - 0000D03F] Intel(R) PRO/1000 MT Network Connection
[0000E000 - 0000E0FF] Realtek AC'97 Audio
[0000E800 - 0000E81F] Intel(R) 82801DB/DBM USB Universal Host Controller - 24C2
[0000EA00 - 0000EA1F] Intel(R) 82801DB/DBM USB Universal Host Controller - 24C4
[0000EB00 - 0000EB3F] Realtek AC'97 Audio
[0000EC00 - 0000EC1F] Intel(R) 82801DB/DBM USB Universal Host Controller - 24C7
[0000F000 - 0000F00F] Intel(R) 82801DB Ultra ATA Storage Controller - 24CB

C2.<Memory Address Map>

[00000000 - 0009FFFF]	System board
[000A0000 - 000BFFFF]	Intel(R) 82845G/GL/GE/PE/GV Graphics Controller
[000A0000 - 000BFFFF]	PCI bus
[000C0000 - 000DFFFF]	PCI bus
[000E0000 - 000EFFFF]	System board
[000F0000 - 000F3FFF]	System board
[000F4000 - 000F7FFF]	System board
[000F8000 - 000FBFFF]	System board
[000FC000 - 000FFFFF]	System board
[00100000 - 3F7EFFFF]	System board
[3F7F0000 - 3F7FFFFF]	System board
[3F800000 - FEBFFFFF]	PCI bus
[E0000000 - E7FFFFFF]	Intel(R) 82845G/GL/GE/PE/GV Graphics Controller
[EC000000 - EC01FFFF]	Intel(R) PRO/1000 MT Network Connection
[EC020000 - EC03FFFF]	Intel(R) PRO/1000 MT Network Connection
[EC060000 - EC060FFF]	OHCI Compliant IEEE 1394 Host Controller
[EC100000 - EC17FFFF]	Intel(R) 82845G/GL/GE/PE/GV Graphics Controller
[EC181000 - EC1811FF]	Realtek AC'97 Audio
[EC182000 - EC1820FF]	Realtek AC'97 Audio
[FEBFFC00 - FEBFFFFF]	Intel(R) 82801DB Ultra ATA Storage Controller - 24CB
[FEC00000 - FEC00FFF]	System board
[FEE00000 - FEE00FFF]	System board
[FFB00000 - FFB7FFFF]	System board
[FFB80000 - FFBFFFFF]	Intel(r) 82802 Firmware Hub Device
[FFF00000 - FFFFFFFF]	System board

C3.<System IRQ & DMA Resources>

DMA:

- 2 Standard floppy disk controller
- 4 Direct memory access controller

IRQ:

- (ISA) 0 System timer
- (ISA) 1 Standard 101/102-Key or Microsoft Natural PS/2 Keyboard
- (ISA) 3 Communications Port (COM2)
- (ISA) 4 Communications Port (COM1)
- (ISA) 6 Standard floppy disk controller
- (ISA) 8 System CMOS/real time clock
- (ISA) 9 Microsoft ACPI-Compliant System
- (ISA) 12 PS/2 Compatible Mouse
- (ISA) 13 Numeric data processor
- (ISA) 14 Primary IDE Channel
- (ISA) 15 Secondary IDE Channel
- (PCI) 9 Intel(R) 82801DB/DBM SMBus Controller - 24C3
- (PCI) 16 Intel(R) 82801DB/DBM USB Universal Host Controller - 24C2
- (PCI) 16 Intel(R) 82845G/GL/GE/PE/GV Graphics Controller
- (PCI) 17 Realtek AC'97 Audio
- (PCI) 18 Intel(R) 82801DB/DBM USB Universal Host Controller - 24C7
- (PCI) 19 Intel(R) 82801DB/DBM USB Universal Host Controller - 24C4
- (PCI) 20 OHCI Compliant IEEE 1394 Host Controller
- (PCI) 21 Intel(R) PRO/1000 MT Network Connection

The GPIO's can be programmed with the MSDOS debug program using simple IN/OUT commands. The following lines show an example how to do this.

GPIO0.....GPIO7 bit0.....bit7

```
-o 2E 87 ;enter configuration
-o 2E 87
-o 2E 29
-o 2E 40 ;enable GPIO function
-o 2E 07
-o 2E 07 ;enable GPIO configuration
-o 2E F0
-o 2F xx ;set GPIO as input/output; set '1' for input,'0'for output
-o 2E F1
-o 2F xx ;if set GPIO's as output,in this register its value can be set
```

Optional :

```
-o 2E F2
-o 2F xx ; Data inversion register ; '1' inverts the current valus of the
bits ,'0' leaves them as they are
-o 2E 30
-o 2F 01 ; active GPIO's
```

For further information ,please refer to Winbond W83627HF datasheet.

Appendix D <Display Setting>

Before you using your display device:

1. Check your software

Before you can use the display device properly, please install the VGA drivers.

2. Check your hardware

Please setup the display device properly before you boot up the system.

For configure your Display device, please follow the instructions below:

1. lunch the display properties.



2. Select settings option and click Advanced Button

3. Select Intel(R) Extreme Graphics and click Graphics properties

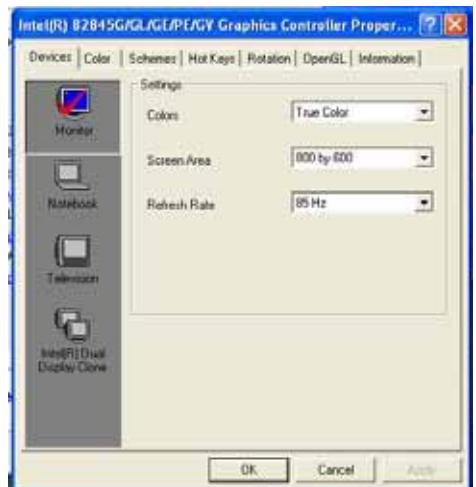
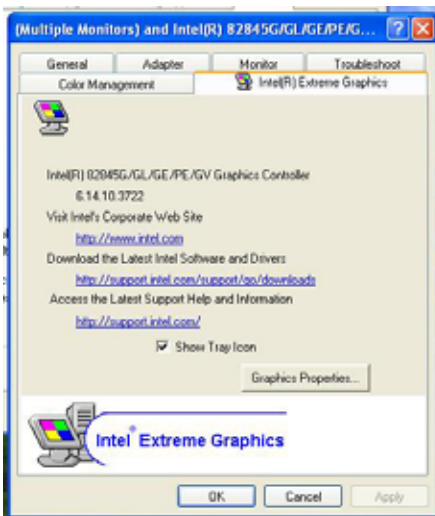

4. There will be a different device list depends on your connecting devices

For Monitor:

You can configure the Colors, Screen area (resolution) and Refresh Rate.

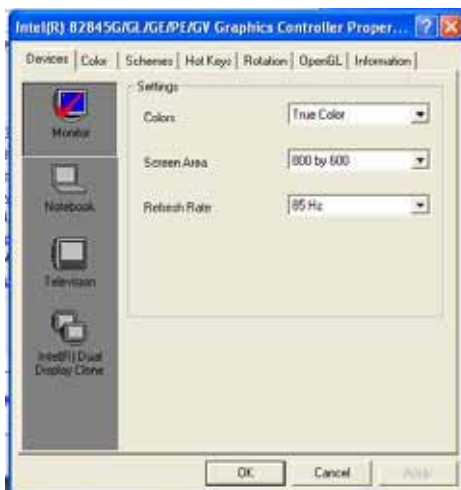

For Notebook:

If you connect a LCD panel though LVDS interface, you can configure the Colors and Screen Area (resolution) here.



Appendix E <How to choose RS-422 & Rs-485>

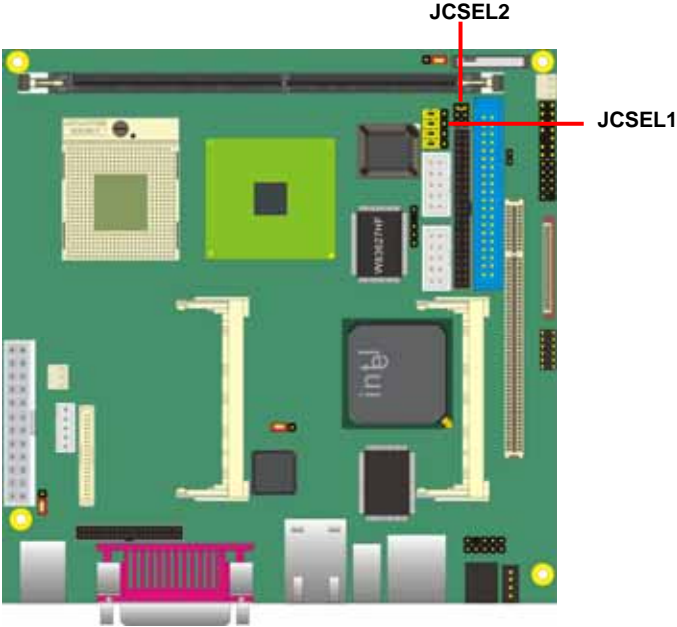
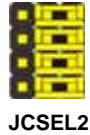
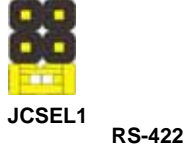
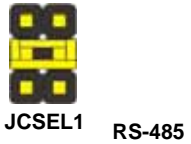
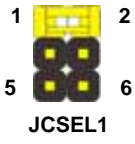

Appendix F <Programming Watchdog Timer >

The watchdog timer makes the system auto-reset while it stops to work for a period. The integrated watchdog timer can be setup as system reset mode by program.

Timeout Value Range

- 1 to 255
- Second or Minute

Program Sample

Watchdog timer setup as system reset with 5 second of timeout

```
-o 2E 87          ;enter configuration
-o 2E 87
-o 2E 07
-o 2F 08          ;enter Logical Device 8
-o 2E F5
-o 2F 00          ;set as Second* Minute: bit 3 = 1; Second: bit 3 = 0
-o 2E F6
-o 2F 05          ;set as 5 Second
```

Contact Information

Any advice or comment about our products and service, or anything we can help you please don't hesitate to contact with us. We will do our best to support you for your products, projects and business.

Taiwan Commate Computer Inc.

Address	8F, No. 94, Sec. 1, Shin Tai Wu Rd., Shi Chih Taipei Hsien, Taiwan
TEL	+886-2-26963909
FAX	+886-2-26963911
Website	http://www.commell.com.tw
E-Mail	info@commell.com.tw (General Information) tech@commell.com.tw (Technical Support)
