



TR-600

Development Document

Version 0.8

Preliminary

Globalsat Technology Corporation
16F., No. 186, Jian-Yi Road, Chung-Ho City, Taipei Hsien 235, Taiwan
Tel: 886-2-8226-3799/ Fax: 886-2-8226-3899
E-mail: service@globalsat.com.tw
Website: www.globalsat.com.tw

CONTENT

1 Introduction	3
2 Protocol Summary	4
2.1 General Format	4
2.2 Format of configuration message	5
2.2.1 Server -> Device	5
2.2.2 Device -> Server	5
2.3 Format of Geo-fence Message	6
2.3.1 Server -> Device	6
2.3.2 Device -> Server	6
2.3.3 Geo-fence area definition format	6
2.4 Format of Command Message	7
2.5 Format of Report Message	8
2.6 Parameters of Report Messages	9
2.7 Codeword of Configuration Parameter	14
2.8 Codeword of Command	33
2.9 Report Media	35
2.10 Action type	36
2.11 Checksum	37
3 Configuration	38
3.1 Read parameters of configuration	38
3.2 Set parameters of configuration	39
4 GSM & GPRS	40
4.1 GPRS Setting	40
4.2 Acknowledgement	41
4.2.1 Receive Acknowledgement from Server	42
4.2.2 Respond Acknowledgement to Server	43
4.3 GPRS connection	44
5 GPS	46
6 Tracking	48
6.1 Ping Report	48
6.2 Motion Report	49
7. Alert	53
7.1 Emergency	53
7.2 Speed Limits	54

7.2.1 Enable Speed Limit Alert	55
7.2.2 Disable Speed Limit Alert	56
7.3 Geo-fence	57
7.3.1 Setup Geo-fence	57
7.3.2 Reading Geo-fence setting	62
7.3.3 Enable Geo-fence Alert	63
7.3.4 Dismiss Geo-fence Alarm	64
7.4 Autonomous Geo-fence	64
7.5 ACC alert.....	66
7.6 Main battery alert	67
7.7 Parking Alert	68
8 Voice Monitor.....	69
9 Timer	71
9.1 Timer 0	71
9.2 Timer 1~3	71
10 Stopwatch	73
11 Counter	75
12 Odometer	77
13 Report Messages	79
13.1 Format 0 of Report Messages.....	79
13.2 Format 1 of Report Messages.....	80
13.3 Format 2 of Report Messages.....	81
13.4 SMS Report.....	82
14 Data Log.....	87
15 Buffer Storage	88
16 I/O port.....	89
16.1 Analog input.....	90
16.2 Digital input.....	91
16.3 Digital output.....	92
17 Simple command.....	94

1 Introduction

TR-600 is a multi-functional and economical communication platform for mobile positioning applications.

It can apply for fleet management, vehicle safety improvement, useful emergency responses, and goods transportation monitor.

The key functions of TR-600 are listed below.

- Report by TCP / UDP / SMS
- Configurable report format and content
- Configurable event triggered action
- 3 digital inputs, 3 digital outputs, 1 analog input
- SOS emergency input
- ACC input
- Speed limit detection
- Odometer
- Battery status monitoring
- Motion detection
- Geo-fence function
- Autonomous geo-fence function
- Voice monitoring
- 4 software event counters
- 4 timers
- 4 stopwatch timers
- Buffer storage (Up to 1400 pieces of data)
- Data logger function

This document describes the communication protocol between TR-600 and application server, the built-in behavior modes of TR-600, and the function of each parameter.

2 Protocol Summary

2.1 General Format

The general format of message is

GS_x,IMEI,[T,S,]Field1,Field2,.....,FieldN*Checksum!

Format	Description	Note
GS_x	"GSS" :Write setting "GSs" :Report setting "GSG" :Write Geo-fence parameter "GSg" :Report Geo-fence parameter "GSC" :Action command "GSr" :Position and status report (format 0) "GSh" :Position and status report (format 1) "GSe" :Cell ID and status report (format 2)	Command head
IMEI	(The IMEI number)	GSM device ID
T	'0' : Middle of sequential message '1' : Start of sequential message '2' : End of sequential message '3' : Start and End of sequential message, i.e., only one packet for message	Message packet sequence control flag
S	'0','1','2','3',....,'9','10','11',....,'99'	Sequence number
Field	Field1 ~ Field N, separated by ',', contain command and/or configuration parameters	Refer to "TR-600 configure parameters" for detail definition
*	*	End of field
Checksum	The checksum value is derived by the same method of NMEA standard. It is calculated by 'exclusive OR' the 8 data bits of each byte before '*' in the sentence, but excluding '*'. The hexadecimal value of the most significant and least significant 4 bits of the result are converted to two ASCII characters (0-9, A-F) for transmission. The most significant	

	character is transmitted first.	
!	!	Message delimiter

2.2 Format of configuration message

2.2.1 Server -> Device

This message is used to configure TR-600 device. Each message could contain as many parameters as required. If the message is too long to be sent in one package, it would be separated into several packets in sequence. The size of each packet is 250 bytes.

The format is

GSS,IMEI,T,S,x1=y1,x2=y2,x3=y3,..... *Check Sum!

Where T field is message packet sequence control flag.

S field is message packet sequence number.

x1,x2,x3... are code words for configuration parameters.

y1,y2,y3... are their respective settings.

For example:

GSS,123456789012345,1,0,A0=1,C0=0,C1=90,C2=20*51!

GSS,123456789012345,0,1,D1=internet,E0=123.234.168.1,E1=5000*04!

GSS,123456789012345,2,2,O3=SORPZAB27GHKLMn*U!*01!

2.2.2 Device -> Server

The message is generated by the TR-600 in accordance with a reading configuration command. If the message is too long, it will be separated into several packets in sequence.

The format is

GSs,IMEI,T,S,x1=y1,x2=y2,x3=y3,..... *Check Sum!

For example:

GSs,123456789012345,1,0,O5=test,O7=F-0TR-600STD-10021421.2.0.1.1*41!

GSS,123456789012345,2,1,OD=02,OS=120*5e!

2.3 Format of Geo-fence Message

2.3.1 Server -> Device

This message is used to configure geo-fence setting. Each message contains as many parameters as desired. If the message to be sent is too long, it is separated to several packets in sequence. The maximum length of each packet is 250 bytes.

The format is

GSG,IMEI,T,S,1=(type,upper_left_Lon,upper_left_Lat,right_bottom_Lon,right_bottom_Lat[,startTime,endTime,weekday]),2=(...),3=(...),... *Check sum!

Where T field is message packet sequence control flag.

S field is message packet sequence number.

1,2,3,... are geo-fence area ID.

Setting of each area is enclosed by (...). Please refer to 2.3.3 & 7.3 for detail.

2.3.2 Device -> Server

The message is generated by TR-600 in accordance with a reading geo-fence setting command. If the message is too long, it will be separated into several packets in sequence.

The format is

GSg,IMEI,T,S,1=(type,upper_left_Lon,upper_left_Lat,right_bottom_Lon,right_bottom_Lat[,startTime,endTime,weekday]),2=(...),3=(...),... *Check sum!

2.3.3 Geo-fence area definition format

*Each geo-fence area is a rectangle represented by the following parameters.
(type,upper_left_Lon,upper_left_Lat,right_bottom_Lon,right_bottom_Lat[,startTime,endTime,weekday])*

type	1=get in area 2=get out of area 3=cross over the boundary 4=stay in area 5=stay out of area
upper_left_Lon upper_left_Lat	The upper left coordinate of specified area.
right_bottom_Lon right_bottom_Lat	The right-bottom coordinate of specified area.
startTime endTime weekday	Optional field for specifying the effective time frame of this geo-fence area. Start Time and end Time are in seconds. Weekday is in hex-digit format which specifies applicable day in a week, where bit 0 represents Sunday, bit1 represents Monday, etc.

2.4 Format of Command Message

A command message is used to set the working mode or control the device activity. A command codeword can combine with configuration setting for best transmission efficiency.

The format is

GSC,IMEI,c1(option1),c2(option2),.....*checksum!

Where

c1,c2...are code words of command.

option1, option2... are configuration parameters and setting. Please refer to section 2.7 for detail.

For example:

GSC,123456789012345,Na,Nk(K1=1,K2=100,K7=c9)*58!

2.5 Format of Report Message

Report message is generated by the TR-600 to inform the application server of its location and status. There are three types of GPRS report message format, “format 0”, “format 1” and “format 2”.

Report format 0 (GSr,...) & format 1 (GSh,...) are configurable reports. They are composed of report prefix and report parameters which are described in section 2.6. Please refer to “Chapter 13. Report” for detailed definitions.

For example:

TR-600 -> Server (format 0)

If configuration parameter O3=SPRXAB27GHKLMn*U!, then the report is GSr,IMEI,Alarm_status,Report_Type,Variable_field,GPS_Fix,UTC_Date,UTC_Time,Longitude,Latitude,Altitude,Speed,Heading,Number_of_Satellites,HDOP, Capacity of battery that presently supplied to TR-600*checksum!

TR-600 -> Server (format 1)

If configuration parameter ON= SARY*U!, then the report is GSh,IMEI,GPS_Fix,Report_type,Joint_IO_status*checksum!

TR-600 -> Server (format 2)

GSe,IMEI,Report_Type,Alarm_Status,X,Date,Time,
“MCC₁,MNC₁,LAC₁,CID₁,BSIC₁,RSSI₁”, “MCC₂,MNC₂,LAC₂,CID₂,BSIC₂,RSSI₂”,
“MCC₃,MNC₃,LAC₃,CID₃,BSIC₃,RSSI₃”,...*checksum!

2.6 Parameters of Report Messages

Parameters of Report Message		
Codeword	Parameters	Description
A	GPS fix status	1=not fix 2=2D fix 3=3D fix
B	UTC Date, Time	ddmmyy,hhmmss
C	Local Date, Time	ddmmyy,hhmmss
1	Longitude	(E or W)ddd.dddddd
2	Longitude	(E or W)dddmm.mmmm
3	Longitude	(+ or -)ddddddddd unit: 0.000001 degree
6	Latitude	(N or S)dd.dddddd
7	Latitude	(N or S)ddmm.mmmm
8	Latitude	(+ or -)ddddddddd unit: 0.000001 degree
G	Altitude	xxxxx Unit: meter
H	Speed	xxx.xx unit: knots (1.852km/hr)
I	Speed	xxx unit: km/hr
J	Speed	xxx unit: mile/hr
K	Heading	xxx unit: degree
L	Number of satellite in use	xx
M	HDOP	xx.x
P	Alarm status	xx(hex digits) bit0=SOS alarm bit1=Parking alarm status bit2=GPS antenna failed bit3=Autonomous geo-fence alarm bit4=Geo-fence alarm bit5=Speed alarm bit6=Main battery disconnection alarm

		bit7=Main battery low alarm
Z	Geo-fence status	Empty field: no geo-fence alarm lxx: get in area xx Oxx: get out area xx
Q	Report Media	xx(hex digits) bit0=SMS bit1=TCP bit2=UDP bit7=GPRS report format
R	Report type	1=Ping report 4=Motion mode static report 5=Motion mode moving report 6=Motion mode static to moving report 7=Motion mode moving to static report G=Geo-fence alarm report H=Autonomous Geo-fence alarm report I=SOS alarm report K=Speed alarm report L=Timer 0 report M=Timer 1 report N=Timer 2 report O=Timer 3 report P=L4 report Q=Stopwatch 0 report R=Stopwatch 1 report S= Stopwatch 2 report T= Stopwatch 3 report V= Digital input report a=Analog input 0 report e=Counter 0 report f=Counter 1 report g=Counter 2 report h=Counter 3 report i=Odometer report j= ACC report k=GPS antenna disconnected l=Main battery disconnected m=Main battery low alarm report

		q=parking alarm report
S	IMEI	
T	Device ID	
U	Checksum	The checksum value is derived by the same method of NMEA standard. It is calculated by 'exclusive OR' the 8 data bits of each character before "*" in the sentence, but excluding "*". The hexadecimal value of the most significant and least significant 4 bits of the result are converted to two ASCII characters (0-9, A-F) for transmission. The most significant character is transmitted first.
V	Digital input status (1=Active, 0=Inactive)	xx (hex digits) bit0= bit1=Input 1 bit2=Input 2 bit3=Input 3 bit4= bit5= bit6= bit7=
W	Digital output status (1=Active, 0=Inactive)	xx (hex digits) bit0= bit1=Output 1 bit2=Output 2 bit3=Output 3 bit4= bit5= bit6= bit7=
X	Variable field, depends on report type	Please refer to the table of X field.
Y	Joint I/O status (1=Active, 0=Inactive)	xxxx (hex digits) bit0= bit1=Input 1 bit2=Input 2 bit3= Input 3

		bit4= bit5= bit6= bit7=Motion status, 0=static, 1=moving bit8= bit9=Output 1 bit10=Output 2 bit11= Output 3 bit12= bit13=ACC bit14=GPS antenna connected bit15=Main battery connected
a	Analog input 0 value	decimal, in mV
e	Counter 0 value	decimal
f	Counter 1 value	decimal
g	Counter 2 value	decimal
h	Counter 3 value	decimal
i	Odometer	Decimal, in meters
m	Main battery voltage	Decimal, in mV
n	Capacity of battery that presently supplied to TR-600	if main battery is connected, n=voltage of main battery (eg, 12300=12.3V) If main battery is not connected, TR-600 would use backup batteries, that is lead-acid battery or Li-battery. if voltage of lead-acid backup battery \geq 5V, n=voltage of lead-acid backup battery (eg, 11800=11.8V) If voltage of lead-acid battery is lower than 5V or lead-acid battery is not connected, TR-600 would be power-supplied by Li-battery. n=capacity of Li backup battery (eg, 80%)
o	Autonomous geo-fence distance	Decimal, in meters
s	IMSI	
#		
*		
?		

!	!	Message delimiter
---	---	-------------------

Report parameter 'X' is variable depending the report type. The relationship is described in the following table.

Report type	Value of X field
1=Ping report	Y: Joint I/O status
4=Motion mode static report	Y: Joint I/O status
5=Motion mode moving report	Y: Joint I/O status
6=Motion mode static to motion report	Y: Joint I/O status
7=Motion mode moving to static report	Y: Joint I/O status
G=Geo-fence alarm report	Z: geo-fence status
H=Autonomous geo-fence alarm report	o: autonomous geo-fence distance
I=SOS alarm report	Y: Joint I/O status
K=Speed alarm report	I: speed (in Km/H)
L=Timer 0 report	Y: Joint I/O status
M=Timer 1 report	Y: Joint I/O status
N=Timer 2 report	Y: Joint I/O status
O=Timer 3 report	Y: Joint I/O status
P=L4 report	Y: Joint I/O status
Q=Stopwatch 0 report	Y: Joint I/O status
R=Stopwatch 1 report	Y: Joint I/O status
S=Stopwatch 2 report	Y: Joint I/O status
T=Stopwatch 3 report	Y: Joint I/O status
V=Digital input report	Y: Joint I/O status
a=Analog input 0 report	a: analog input value
e=Counter 0 report	e: counter 0 value
f=Counter 1 report	f: counter 0 value
g=Counter 2 report	g: counter 0 value
h=Counter 3 report	h: counter 0 value
i=Odometer	i: Odometer value
j=ACC report	Y: Joint I/O status
k=GPS antenna disconnected	Y: Joint I/O status
l=Main battery disconnected	Y: Joint I/O status
m=Main battery low alarm report	m: main battery voltage
q=Parking alarm report	Y: Joint I/O status

2.7 Codeword of Configuration Parameter

Most behaviors of TR-600 could be changed by Configuration Parameters. You could change the setting of configuration parameters by the following methods.

1. Connect TR-600 to personal computer via RS-232 cable and then set the configuration parameters by “TR600ConfigTool_DEV.exe”.
2. Send the “GSS,....!” setting with the configuration parameters to TR-600
3. Send the “GSC,....!” command with the configuration parameters to TR-600

All the settings or commands could be sent by SMS or TCP or UDP.

You could also send L1 command to read the present setting of TR-600.

Configuration Parameters

	Code words	Parameters	Type	Description	
Main	Device	O5	Device ID	char(16)	
		O7	Firmware Version	char(28)	Read only
		O6	Time Zone Offset	s32, in seconds	-43200 ~ 46800
		B2	IMEI number	char(16)	Read only
	SIM	B0	PIN code	char(7)	
		B1	Phone number of SIM card	char(19)	
		B3	IMSI number	char(16)	Read only
	Battery	J6	Battery alarm report Media	Media type	bit0=SMS bit1=TCP bit2=UDP bit7=GPRS report format
		J9	The power capacity for main battery power low alarm	u16, in mV	Default=11500
		JA	The action for main battery disconnection alarm	Action type	Please refer to section 2.10 for detail.

	JB	The action for backup battery power low alarm	Action type	Please refer to section 2.10 for detail.
Data logger	O2	Data logger interval	u16, in seconds	0 ~ 65535 0=disable
	OH	Data logger distance	u32, in meters	0 ~ 4 Giga 0=disable
Other setting	O3	Report format 0	char(32)	Default= SPRXAB27GHKLMn*U!
	ON	Report format 1	char(32)	Default=SARY*U!
	OG	Enable/ disable data buffer function	1/0	Default=1
	O8	Enable/ disable TR-600 to report "cell ID" if it does not get GPS fix	1/0	Default=0. The report format will automatically switch from format 0 to format 2 when TR-600 does not get GPS fix.
	OB	Debug message output media	u8	1=debug port (RS-232) 2=in device Default=2
	OC	Debug message level	u8	1=all message 4=NEMA only
	OO	Report media for reading configuration	Media type	bit1=TCP bit2=UDP bit6=debug port
	Oa	Password of simple command	Char(7)	
GPS	C1	The time for starting to get GPS fix before the next report time if TR-600 does not get GPS fix in last report, or got a GPS fix 1 hour ago	u16, in seconds	60 ~ 600 Note: TR-600 will send out the report whether it gets GPS fix or not when C1 time ends.
	C2	The time for starting to get GPS fix before	u16, in seconds	10 ~ 120 Note: TR-600 will send out the report

			the next report time if TR-600 got a GPS fix within 1 hour		whether it gets GPS fix or not when C2 time ends.
		C3	GPS fix time before sending out the first report	u16, in seconds	0 ~ 600 If "C3"=0, disable first report message.
		C5	Enable NMEA output message	1/0	0=disable 1=enable Default=0
		CC	Report media for GPS antenna disconnected	Media type	
		CD	Action for GPS antenna disconnected	Action type	Please refer to section 2.10 for detail.

Communication	GPRS	D1	APN	char(32)	
		D2	User Name	char(32)	
		D3	Password	char(32)	
		D4	DNS 1	char(32)	
		D5	DNS 2	char(32)	
		D8	GPRS mode for L4 command	Media type	02=TCP 04=UDP
		E0	Host IP or domain name 1	char(32)	
		E1	Host Port number 1	u16	
		E4	Interval in on-line state for disconnecting and then re-connecting	u16, in seconds	0,60~65535 0=disable
		E5	Interval for checking if GPRS connection is on-line. If GPRS connection is cut, TR-600 will try to connect to server for one time.	u16, in seconds	0=disable

		E6	Enable/disable TR-600 to send "OK" to server after GPRS connection is re-built.	1/0	0=disable 1=enable Available when E5 is not 0
		E7	Timeout of L4 connection	u16, in seconds	>=2, default=30
		EA	Time for keeping GPRS connection after sending report	u8, in seconds	>=2, default=2
SMS		F0	SMS return phone number	char(20)	
		F2	SMS format 1	1/0	0= Same as GPRS format 1= Text format
		BA	SMS format 1 report string for ping	char(96)	
		BB	SMS format 1 report string for SOS alarm	char(96)	
		BC	SMS format 1 report string for GPS disconnection	char(96)	
		BD	SMS format 1 report string for ACC deactivation	char(96)	
		BE	SMS format 1 report string for ACC activation	char(96)	
		BF	SMS format 1 report string for digital input 1 deactivation	char(96)	
		BG	SMS format 1 report string for digital input 1 activation	char(96)	

		BH	SMS format 1 report string for digital input 2 deactivation	char(96)	
		BI	SMS format 1 report string for digital input 2 activation	char(96)	
		BJ	SMS format 1 report string for digital input 3 deactivation	char(96)	
		BK	SMS format 1 report string for digital input 3 activation	char(96)	
		BL	SMS format 1 report string for analog input	char(96)	
		BM	SMS format 1 report string for main battery disconnection	char(96)	
		BN	SMS format 1 report string for main battery low	char(96)	
		BO	SMS format 1 report string for geo-fence alarm	char(96)	
		BP	SMS format 1 report string for autonomous geo-fence alarm	char(96)	
		BQ	SMS format 1 report string for odometer	char(96)	
		BR	SMS format 1 report string for counter 0	char(96)	
		BS	SMS format 1 report string for counter 1	char(96)	
		BT	SMS format 1 report string for counter 2	char(96)	

BU	SMS format 1 report string for counter 3	char(96)	
BV	SMS format 1 report string for static state of motion mode	char(96)	
BW	SMS format 1 report string for moving state of motion mode	char(96)	
BX	SMS format 1 report string for changing from static to moving state	char(96)	
BY	SMS format 1 report string for changing from moving to static state	char(96)	
Ba	SMS format 1 report string for high speed alarm	char(96)	
Bb	SMS format 1 report string for low speed alarm	char(96)	
Bc	SMS format 1 report string for timer 0	char(96)	
Bd	SMS format 1 report string for timer 1	char(96)	
Be	SMS format 1 report string for timer 2	char(96)	
Bf	SMS format 1 report string for timer 3	char(96)	
Bg	SMS format 1 report string for stopwatch 0	char(96)	
Bh	SMS format 1 report string for stopwatch 1	char(96)	

		Bi	SMS format 1 report string for stopwatch 2	char(96)	
		Bj	SMS format 1 report string for stopwatch 3	char(96)	
		Bk	SMS format 1 report string for parking alarm report	char(96)	
	Acknowledgement	A0	Send confirmation to server after receiving command from server	1/0	0=disable 1=enable Confirmation message="ACK\r"
		A1	Wait confirmation from server after sending message to server	1/0	0=disable 1=enable Confirmation message="ACK\r"
		A2	Timeout of waiting confirmation from server	u8	1~255
		A3	Device ACK with ID string	1/0	0=disable 1=enable
		A4	ID string is IMEI or device ID	1/0	0=Device id 1=IMEI Available when A3=1
		A5	Enable Simple Command	1/0	0=disable 1=enable
Security	SOS	G0	SMS Phone number 1	char(20)	
		G1	SMS Phone number 2	char(20)	
		G2	SMS Phone number 3	char(20)	
		G3	SMS Phone number 4	char(20)	
		G4	SMS Phone number 5	char(20)	

	G5	SMS Phone number 6	char(20)	
	H0	Report media of SOS	Media Type	00=Disable 01=SMS 02=TCP 04=UDP
	H1	Max number of SMS report for each phone number	u16	1~65535
	H2	report interval	u16, in seconds	3 ~ 65535
	H3	Number of GPRS report	u8	0=continuous
Voice Monitor	V0	Call out SOS phone number 1 when SOS alarm	1/0	0=disable 1=enable
	V4	Voice Monitor call in/out phone number 1 for voice monitor command	char(20)	
	V5	Allowed interval for calling in to the TR-600 after receiving the voice monitor command	u16, in seconds	10 ~ 65535 Available when V6=0 Default=120
	V6	Call in or call out for voice monitor command	1/0	0=Call in 1=Call out
	V8	Voice Monitor call in phone number 2 for voice monitor command	char(20)	
	V9	Voice Monitor call in phone number 3 for voice monitor command	char(20)	

Speed Limit	SA	Upper limit of speed alarm	u8, in Km/h	0 ~ 255 0=disable, default=0
	SB	Lower limit of speed alarm	u8, in Km/h	0 ~ 255 0=disable, default=0
	SC	Hysteresis for speed alarm	u8, in Km/h	0 ~ 255, default=5
	SD	Report Media for speed alarm	Media type	bit0=SMS bit1=TCP bit2=UDP bit7=GPRS report format
	SE	Action for high speed alarm	Action type	Please refer to section 2.10 for detail.
	SF	Action for low speed alarm	Action type	Please refer to section 2.10 for detail.
Parking Alarm	SI	Enable parking alert	1/0	0=disable 1=enable Default=0
	SJ	Triggering source of parking alarm	xxxx (hex digits)	Bit 1=Din1 Bit 2=Din2 Bit 3=Din3 Bit 7=Motion Sensor Bit 13=ACC Default=2080
	SK	Report media of parking alarm	Media type	Please refer to 2.9 report media
	SL	Action type of parking alarm	Action type	Please refer to 2.10 action type
Geo-fence	K0	Geo-fence enable	1/0	0=disable 1=enable Default=0
	K1	Enable/disable autonomous geo-fence	1/0	0=disable 1=enable Default=0
	K2	Autonomous geo-fence radius	u32, in meter	30~4Giga Default=100
	K3	Geo-fence alarm	Media	bit0=SMS

			report Media	type	bit1=TCP bit2=UDP bit7=GPRS report format	
		K4	Report media for reading Geo-fence data	Media type	bit1=TCP bit2=UDP	
		K6	Action for geo-fence alarm	Action type	Please refer to section 2.10 for detail.	
		K7	Action for autonomous geo-fence alarm	Action type	Please refer to section 2.10 for detail.	
Tracking	Ping	OD	Report media for ping	Media type	bit0=SMS bit1=TCP bit2=UDP bit7=GPRS report format	
		OS	GPS fix time between receiving ping command and sending out ping report	u16, in seconds	For N1 & L4 command. If OS=0, GPS fix time=C3	
	Tracking (Static state)	Ra	Report interval in static state	u32, in seconds	0, 3 ~ 4Giga 0=disable	
		Rb	Report media in static state	Media type	bit0=SMS bit1=TCP bit2=UDP bit7=GPRS report format	
		Rc	Action for static report	Action type	Please refer to section 2.10 for detail.	
		Rd	GPS always on in static state	1/0	0=disable 1=enable	
		Re	Turn off GSM in static state	1/0	0=turn on GSM module 1=turn off GSM module	
		Rf	Keep GPRS on-line in static state	1/0	Available when Re=0 0=disable 1=enable	

Tracking (Moving state)	Ri	Report interval in moving state	u32, in seconds	0, 3 ~ 4 Giga 0=disable
	Rj	Report media in moving state	Media type	bit0=SMS bit1=TCP bit2=UDP bit7=GPRS report format
	Rk	Action for moving report	Action type	Please refer to section 2.10 for detail.
	RI	GPS always on in moving state	1/0	0=disable 1=enable
	Rn	Keep GPRS on-line in moving state	1/0	0=disable 1=enable
	Ro	Traveled distance for sending report	u32, in meters	0, 50 ~ 4 Giga 0=disable
	Rp	Traveled distance to be judged as keep in moving state	u16, in meter	0, 50 ~ 4 Giga 0=disable
Tracking (Switching state)	Rs	Report Media for switching from static to moving state	Media type	bit0=SMS bit1=TCP bit2=UDP bit7=GPRS report format
	Rt	Report Media for switching from moving to static state	Media type	bit0=SMS bit1=TCP bit2=UDP bit7=GPRS report format
	Ru	Action for switching from static to moving state	Action type	Please refer to section 2.10 for detail.
	Rv	Action for switching from moving to static state	Action type	Please refer to section 2.10 for detail.
	Rw	Minimum distance to be judged as moving state	u16, in meters	0, 30 ~ 65535 0=disable
	Rx	Interval for switching from validation to static	u16, in seconds	0=Interval is the same with Ri 3~65535

			state if no motion detected			
		Ry	Interval for switching from moving to static state if no motion detected	u16, in seconds	0=Interval is the same with Ri 3~65535	
		Rz	Motion sensor sensitivity	u16,	0=disable Default=5	
Timer	Timer 0	W0	Start time	u32, in seconds	0 ~ 86399 Default=0	
		W1	End time	u32, in seconds	1 ~ 86400 Default=86400	
		W2	Report interval	u16, in seconds	1 ~ 65535 Default=3600	
		W3	Weekday mask	u8, xx(hex digits)	00 ~ 7f Weekday is in hex-digit format which specifies applicable day in a week, where bit 0 represents Sunday, bit1 represents Monday, etc.	
		W4	Report Media	Media type	bit0=SMS bit1=TCP bit2=UDP bit7=GPRS report format	
		W5	Action	Action type	Please refer to section 2.10 for detail.	
	Timer 1	X0	Start time	u32, in seconds	0 ~ 86399 Default=0	
		X1	End time	u32, in seconds	1 ~ 86400 Default=86400	
		X2	Report interval	u16, in seconds	1 ~ 65535 Default=3600	
		X3	Weekday mask	u8,	00 ~ 7f	
			xx(hex	Weekday is in hex-digit format which		

			digits)	specifies applicable day in a week, where bit 0 represents Sunday, bit1 represents Monday, etc.
	X4	Report Media	Media type	bit0=SMS bit1=TCP bit2=UDP bit7=GPRS report format
	X5	Action	Action type	Please refer to section 2.10 for detail.
Timer 2	Y0	Start time	u32, in seconds	0 ~ 86399 Default=0
	Y1	End time	u32, in seconds	1 ~ 86400 Default=86400
	Y2	Report interval	u16, in seconds	1 ~ 65535 Default=3600
	Y3	Weekday mask	u8, xx(hex digits)	00 ~ 7f Weekday is in hex-digit format which specifies applicable day in a week, where bit 0 represents Sunday, bit1 represents Monday, etc.
	Y4	Report Media	Media type	bit0=SMS bit1=TCP bit2=UDP bit7=GPRS report format
	Y5	Action	Action type	Please refer to section 2.10 for detail.
Timer 3	Z0	Start time	u32, in seconds	0 ~ 86399 Default=0
	Z1	End time	u32, in seconds	1 ~ 86400 Default=86400
	Z2	Report interval	u16, in seconds	1 ~ 65535 Default=3600
	Z3	Weekday mask	u8, xx(hex digits)	00 ~ 7f Weekday is in hex-digit format which specifies applicable day in a week, where bit 0 represents Sunday, bit1

					represents Monday, etc.	
		Z4	Report Media	Media type	bit0=SMS bit1=TCP bit2=UDP bit7=GPRS report format	
		Z5	Action	Action type	Please refer to section 2.10 for detail.	
Stopwatch	Stopwatch 0	WA	Report interval	u32, in seconds	0, 3~4Giga Default=60	
		WB	Number of report	u8	0=continuous Default=1	
		WC	Report media	Media type	bit0=SMS bit1=TCP bit2=UDP bit7=GPRS report format	
		WD	Action	Action type	Please refer to section 2.10 for detail.	
		WE	Enable/disable stopwatch	1/0	0=disable stopwatch 1=enable stopwatch	
	Stopwatch 1		XA	Report interval	u32, in seconds	0, 3~4Giga Default=60
			XB	Number of report	u8	0=continuous Default=1
			XC	Report media	Media type	bit0=SMS bit1=TCP bit2=UDP bit7=GPRS report format
			XD	Action	Action type	Please refer to section 2.10 for detail.
XE			Enable/disable stopwatch	1/0	0=disable stopwatch 1=enable stopwatch	

Stopwatch 2					
Stopwatch 2	YA	Report interval	u32, in seconds	0, 3~4Giga Default=60	
	YB	Number of report	u8	0=continuous Default=1	
	YC	Report media	Media type	bit0=SMS bit1=TCP bit2=UDP bit7=GPRS report format	
	YD	Action	Action type	Please refer to section 2.10 for detail.	
	YE	Enable/disable stopwatch	1/0	0=disable stopwatch 1=enable stopwatch	
Stopwatch 3					
Stopwatch 3	ZA	Report interval	u32, in seconds	0, 3~4Giga Default=60	
	ZB	Number of report	u8	0=continuous Default=1	
	ZC	Report media	Media type	bit0=SMS bit1=TCP bit2=UDP bit7=GPRS report format	
	ZD	Action	Action type	Please refer to section 2.10 for detail.	
	ZE	Enable/disable stopwatch	1/0	0=disable stopwatch 1=enable stopwatch	
Counter	Counter 0	Pa	Occurring frequency for counter 0 to report/ make action	u32,	0=no action/ report
		Pb	Automatically reset counter	1/0	1=enable 0=disable

	Pc	Report media of counter	Media type	bit0=SMS bit1=TCP bit2=UDP bit7=GPRS report format
	Pd	Action for counter	Action type	Please refer to section 2.10 for detail.
Counter 1	Pg	Occurring frequency for counter 1 to report/ make action	u32,	0=no action/ report
	Ph	Automatically reset counter	1/0	1=enable 0=disable
	Pi	Report media of counter	Media type	bit0=SMS bit1=TCP bit2=UDP bit7=GPRS report format
	Pj	Action for counter	Action type	Please refer to section 2.10 for detail.
Counter 2	Pm	Occurring frequency for counter 2 to report/ make action	u32	0=no action/ report
	Pn	Automatically reset counter	1/0	1=enable 0=disable
	Po	Report media of counter	Media type	bit0=SMS bit1=TCP bit2=UDP bit7=GPRS report format
	Pp	Action for counter	Action type	Please refer to section 2.10 for detail.
Counter 3	Ps	Occurring frequency for counter 3 to report/ make action	u32	0=no action/ report

		Pt	Automatically reset counter	1/0	1=enable 0=disable
		Pu	Report media of counter	Media type	bit0=SMS bit1=TCP bit2=UDP bit7=GPRS report format
		Pv	Action for counter	Action type	Please refer to section 2.10 for detail.
Odometer		PA	Traveled GPS distance for odometer to report / make action.	u32, in meters	0, 50~4Giga
		PC	Report media of odometer	Media type	bit0=SMS bit1=TCP bit2=UDP bit7=GPRS report format
		PD	Action for odometer	Action type	Please refer to section 2.10 for detail.
		PE	Enable/ disable odometer	1/0	0=disable 1-enable Default=1
IO Port	Analog Input	QA	Upper threshold of analog input	u16, in mV	0=no trigger
		QB	Lower threshold of analog input	u16, In mV	0=no trigger
		QC	Report media of analog input	Media type	bit0=SMS bit1=TCP bit2=UDP bit7=GPRS report format
		QD	Action for analog input	Action type	Please refer to section 2.10 for detail.
		QE	Check interval	u16, in seconds	0=disable

ACC Input	Qa	Report media when ACC input is activated	Media type	bit0=SMS bit1=TCP bit2=UDP bit7=GPRS report format
	Qb	Report media when ACC input goes inactive	Media type	bit0=SMS bit1=TCP bit2=UDP bit7=GPRS report format
	Qc	Action when ACC input is activated	Action type	Please refer to section 2.10 for detail.
	Qd	Action when ACC input goes inactive	Action type	Please refer to section 2.10 for detail.
Digital Input 1	Qg	Report media when digital input is activated	Media type	bit0=SMS bit1=TCP bit2=UDP bit7=GPRS report format
	Qh	Report media when digital input goes inactive	Media type	bit0=SMS bit1=TCP bit2=UDP bit7=GPRS report format
	Qi	Action when digital input is activated	Action type	Please refer to section 2.10 for detail.
	Qj	Action when digital input goes inactive	Action type	Please refer to section 2.10 for detail.
Digital Input 2	Qm	Report media when digital input is activated	Media type	bit0=SMS bit1=TCP bit2=UDP bit7=GPRS report format
	Qn	Report media when digital input goes inactive	Media type	bit0=SMS bit1=TCP bit2=UDP bit7=GPRS report format

	Qo	Action when digital input is activated	Action type	Please refer to section 2.10 for detail.
	Qp	Action when digital input goes inactive	Action type	Please refer to section 2.10 for detail.
Digital Input/ 3	Qs	Report media when digital input is activated	Media type	bit0=SMS bit1=TCP bit2=UDP bit7=GPRS report format
	Qt	Report media when digital input goes inactive	Media type	bit0=SMS bit1=TCP bit2=UDP bit7=GPRS report format
	Qu	Action when digital input is activated	Action type	Please refer to section 2.10 for detail.
	Qv	Action when digital input goes inactive	Action type	Please refer to section 2.10 for detail.
Digital input all	Qy	Digital input status	xx(hex digit)	Read only
Digital output all	Qz	Digital output status	xx(hex digit)	Bit1=Output 1 Bit2=Output 2 Bit3=Output 3 (0=inactive, 1=active)

2.8 Codeword of Command

Commands are used to control the device activity. A command message is composed of one or several command codeword. Each command codeword can incorporate configuration parameter setting. Please refer to section 2.4 for message format. Command message could be sent by SMS or TCP or UDP.

Command's Codeword		
Codeword	Parameters	Description
M4	Restart motion sensor activity	
N1	Ping device	
N4	Enable voice monitor	
N6	Enable Geo-fence	
N7	Disable Geo-fence	
N8	Enable Data logger	
N9	Disable Data logger	
Na	Dismiss SOS alarm	
Ne	Dismiss geo-fence alarm	
Nk	Enable autonomous geo-fence	
NI	Disable autonomous geo-fence	
Nm	Dismiss autonomous geo-fence alarm	
L1	Read Configuration	Adding up to 1-5 parameters. If parameter=(ALL), then all user configuration data will be reported.
L3	Read Geo-fence	
L4	Make TR-600 connect to Server	
L5	Disconnect from Server	
LA	Restore default configuration	No argument: Restore all parameters to default setting.

		(W): for saving current configuration as default setting.
LB	Start to dump data logger	
LC	Clear data logger	
LH	Reset device	
LJ	Send SMS message	(Phone number, "00SMS content")
Lc	Counter control	(n,0/1), n=0~3, 0=clear, 1=increment
Ld	Odometer control	(C)=clear, (D)=disable, (E)=enable
Lo	Digital output control	(n,0/1), n=digital output 1~3, 0=deactivate, 1=activate

Example: Ask TR-600 to send configuration parameters.

GSC,123456789012345,L1(Ra,Rb,Rc,Ri,Rj)*2a!

Example: Ask TR-600 to restore default configuration.

GSC,123456789012345,LA*6a!

Example: Ask TR-600 to send SMS message to 0918518518.

GSC,123456789012345,LJ(0918518518,"Please call service center ASAP.")*3b!

Example: Ask TR-600 to clear counter 2 & counter 3.

GSC,123456789012345,Lc(2,0),Lc(3,0)*4a!

Example: Ask TR-600 to enable odometer and connect to server immediately.

GSC,123456789012345,Ld(E),L4*5f!

Example: Ask TR-600 to activate digital output 3.

GSC,123456789012345,Lo(3,1)*3b!

2.9 Report Media

Report media is the method that TR-600 sends report. No matter how you send the command by SMS or TCP or UDP, TR-600 will send the report according to the appropriate report media setting.

Report Media	Media type	bit0=SMS bit1=TCP bit2=UDP bit7=GPRS report format
--------------	------------	---

Bit 0: 1=send by SMS, 0=disable SMS report

Bit 1: 1=send by TCP, 0=disable TCP report

Bit 2: 1=send by UDP, 0=disable UDP report

Bit 7: 1=send by format 1, 0=send by format 0

A report media byte is represented by 2 hex digits. Unused bits must be set to 0.

bit	Report Media Type							
	7=GPRS report format	6=	5	4	3	2=UDP	1=TCP	0=SMS
Ex 1 TCP by format 0	0	0	0	0	0	0	1	0
Ex 2 UDP by format 1	1	0	0	0	0	1	0	0
Ex 2 UDP by format 0	0	0	0	0	0	1	0	0

Example 1: Ask TR-600 to send motion report with report static interval of 5 minutes (Ra=300) and report format 0 to TCP server (Rb=02).

GSC,011412000010789,M4(Ra=300,Rb=02)*01!

Example 2: Ask TR-600 to send static report with report interval of 7 minutes (Ra=420) by format 1 (Rb=84) and moving report with interval of 20 seconds (Ri=20) with format 0 (Rj=04), to UDP server.

GSC,011412000010789,M4(Ra=420,Rb=84,Ri=20,Rj=04)*2f!

2.10 Action type

There are several events that will trigger defined actions. Those events include digital input transition, analog input exceeding a threshold, detecting motion, high speed alarm, geo-fence alarm, battery low alarm, etc. Please refer to configuration parameters that are of action type.

Action type is used to define the activity when the event happens. Please refer to the following table for possible activities. Action type is represented by 2 hex digits.

For example, if you want to measure the occurring frequency of high speed alarm, you could set the action type of high speed alarm to be increment counter0. The parameter could be set as SE=A8. (SE is the configuration parameter of high speed alarm. A8 is the code of increment counter0).

Action type	Code
Disable stopwatch 0~3	84H~87H
Enable stopwatch 0~3	8CH~8FH
Clear counter 0~3	A0H~A3H
Increment counter 0~3	A8H~ABH
Reset digital output 1~3	C1H~C3H
Set digital output 1~3	C9H~CBH
Clear odometer	40H
Disable odometer	42H
Enable odometer	43H
Turn off tracker	44H
Turn on tracker	45H
Disable autonomous geo-fence	48H
Enable autonomous geo-fence	49H

Example 1: Ask TR-600 to increment counter 0 (SE=A8) when the speed is over 70 km/hr (SA=70).

GSS,10339376540375,3,0,SA=70,SE=A8*18!

2.11 Checksum

The checksum value is derived by the same method of NMEA standard. It is calculated by 'exclusive OR' the 8 data bits of each character before "*" in the sentence, but excluding "*". The hexadecimal value of the most significant and least significant 4 bits of the result are converted to two ASCII characters (0-9, A-F) for transmission. The most significant character is transmitted first.

Example1: set the device whose IMEI is 011412000011274, the APN is internet, the user name and password are not necessary, the server type is TCP, the server IP is 220.128.207.75, the server port number 3000.

The setup command is

GSS,011412000011274,3,1,D1=internet,D2=,D3=,D8=02,E0=220.128.207.75,E1=3000*5E!

The checksum is 5E.

Example2: Set TR-600 periodic report and ask it to report based on traveled distance (Ro) of 500 meters

The setup command is

GSC,011412000010789,M4(Ro=500)*2a!

The checksum is 2a.

3 Configuration

TR-600 has a very flexible platform. Its behavior is totally configurable. Please refer to section 2.7 for the list of configuration parameters.

3.1 Read parameters of configuration

The PC tool "TR600ConfigTool_DEV.exe" is used to configure the device by RS-232 interface. You could also send L1 command to remotely read back the setting by TCP or UDP protocol.

Please note TR-600 could **NOT** send back the configuration parameter by SMS.

Command's format:

GSC,IMEI,L1(x1,x2,x3,x4,x5)*Checksum!

GSC,IMEI,L1(ALL)*Checksum!

Add up to 1-5 parameters.

If parameter =(ALL), then all user configuration data will be generated.

Report format:

GSs,IMEI,T,S,x1=y1,x2=y2,x3=y3,.....*Checksum!

x1,x2,x3... are code words for configuration parameters.

y1,y2,y3... are their respective settings.

Example 1:

Ask TR-600 report parameters of speed limits(SA, SB, SC, SD, SE)

GSC,136489586301578,L1(SA,SB,SC,SD,SE)*0b!

Report parameters SA,SB,SC,SD,SE, from TR-600

GSs,136489586301578,3,0,SA100,SB=40,SC=5,SD=02,SE=A8*3f!

3.2 Set parameters of configuration

The setting of configuration parameters could be changed by the following methods.

- Connect TR-600 to personal computer via RS-232 cable and then set the configuration parameters by “TR600ConfigTool_DEV.exe”.
- Send the “GSS,....!” setting with the configuration parameters to TR-600
- Send the “GSC,....!” command with the configuration parameters to TR-600

All the settings or commands could be sent by SMS or TCP or UDP.

Command format:

GSS,IMEI,T,S,x1=y1,x2=y2,x3=y3,.....,*Checksum!

x1,x2,x3... are code words for configuration parameters.

y1,y2,y3... are their respective settings.

Example 1:

Set parameters of GPRS setting (D1,E0,E1)

Codeword	Parameters	Value
D1	APN	Internet
E0	Host IP 1	201.89.56.207
E1	Host Port number 1	5000

GSS,138785469589531,3,0,D1=internet,E0=201.89.56.207,E1=5000*01!

Example 2:

Ping TR-600 and set parameters of Timer 1: Start time: 09:00 AM (X0=32400),

End time: 06:00 PM (X1=64800), Report interval: 1 hour (X2=3600), Report day:

from Monday ~Friday (X3=3E)

GSC,011412000012789,N1(X0=32400,X1=64800,X2=3600,X3=3E)*4b!

4 GSM & GPRS

4.1 GPRS Setting

In order to activate the communication between server and device, the GPRS parameter is necessary to be set at the beginning. The GPRS parameters are listed as the table below. Please contact with your telecom operator for the APN, user name, and password.

Please contact your ISP provider for DNS1 and DNS2.

GPRS	D1	APN	char(32)	
	D2	User Name	char(32)	
	D3	Password	char(32)	
	D4	DNS 1	char(32)	
	D5	DNS 2	char(32)	
	E0	Host IP 1 or domain name	char(32)	Fixed IP or domain name
	E1	Host Port number 1	u16	

Note:

1. If user name and password are not necessary for your telecom operator, please keep D2 and D3 blank.
2. If the value of E0 is an IP, then you do not have to set D4 and D5. Please skip the fields.

The setup format of GPRS setting is “**GSS,IMEI,T,S,D1=y1,D2=y2,D3=y3,D4=y4, D5=y5, D8=y6,E0=y7,E1=y8,*Checksum!**”

For example, set the device whose IMEI is 011412000010789, the APN is internet, the user name and password are not necessary, the server type is TCP, the server IP is 220.128.207.75, the server port number is 5000.

The setup command is

GSS,011412000010789,3,0,D1=internet,D2=,D3=,D8=02,E0=220.128.207.75,E1=5000*5f!

4.2 Acknowledgement

Acknowledgement is the acknowledge receipt used to confirm if server or device receives the command or report from each other.

Code word	Parameters	Value	Description
A0	Send confirmation to server after receiving command from server	1/0	1=Enable 0=Disable
A1	Wait confirmation from server after sending message to server	1/0	1=Enable 0=Disable Confirmation message="ACK\r"
A2	Timeout of waiting confirmation from server	u8	0~255 Default=5
A3	Device Ack with ID string	1/0	
A4	ID string is IMEI or device ID	1/0	1=IMEI, 0=Device ID Available when A3=1

The confirmation message from the device is defined in the table below.

A0	A3	A4	Confirmation message
0	x	x	No confirmation required
1	0	x	"ACK\r"
1	1	0	"Device ID, ACK\r"
1	1	1	"IMEI, ACK\r"

Note: "Device ID" is defined by O5.

For example, set A0=1, A1=1, A3=1, A4=1, server sends command to TR-600 whose IMEI is 011412000010789. After receiving command, TR-600 will send acknowledgement receipt as "011412000010789,ACK\r"

For example, set A0=1, A1=1, A3=1, A4=0 and O5="Globalsat" (device ID). After receiving command, TR-600 will send acknowledgement receipt as "Globalsat,ACK\r"

For example, set A0=1, A1=1, A3=0. After receiving the command, TR-600 will send acknowledgement receipt as "ACK\r"

4.2.1 Receive Acknowledgement from Server

Received ACK from server during "A2" time:

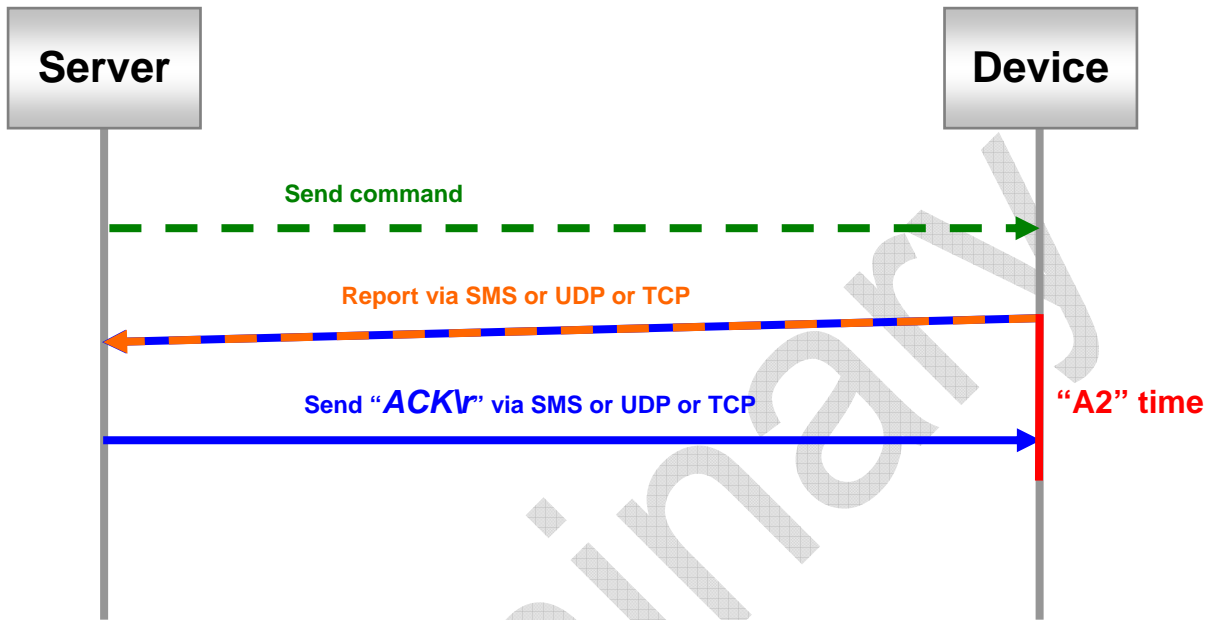

Didn't receive ACK from server during "A2" time:

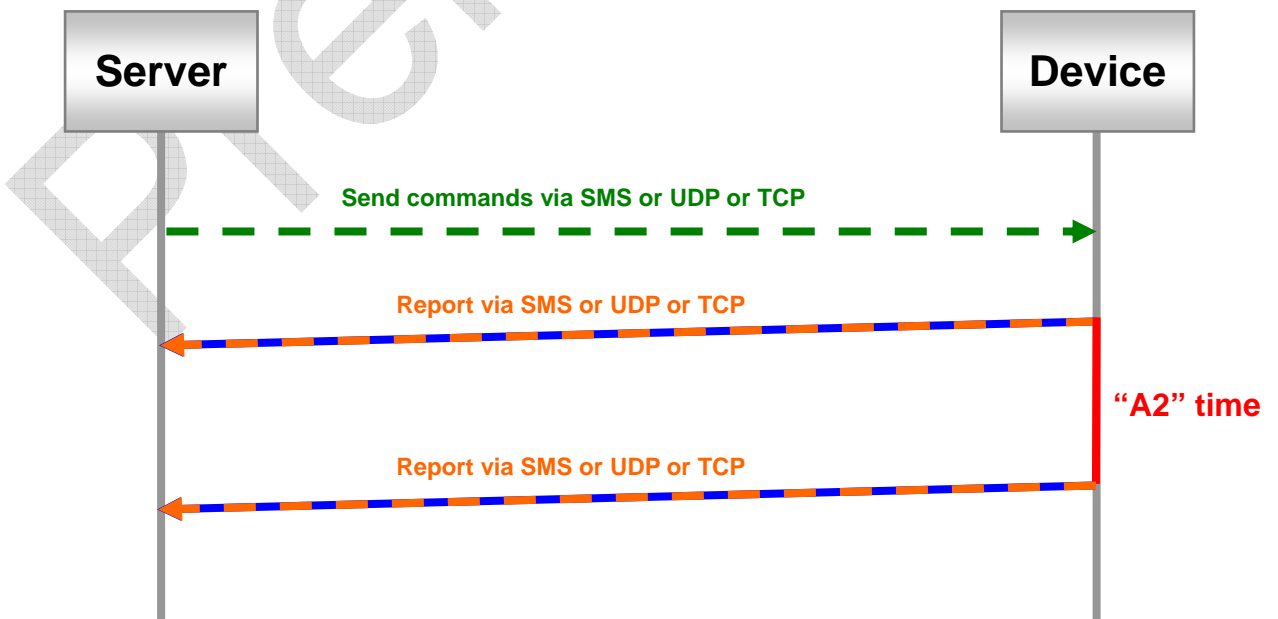

4.2.2 Respond Acknowledgement to Server

Receive report command from server:

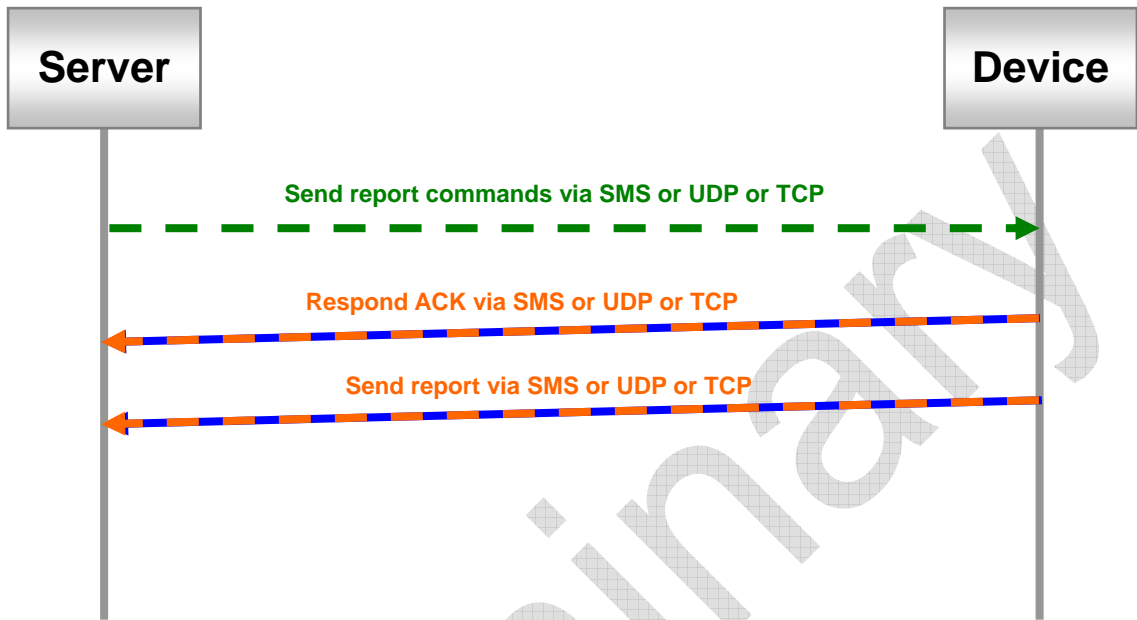

Receive other command from server:

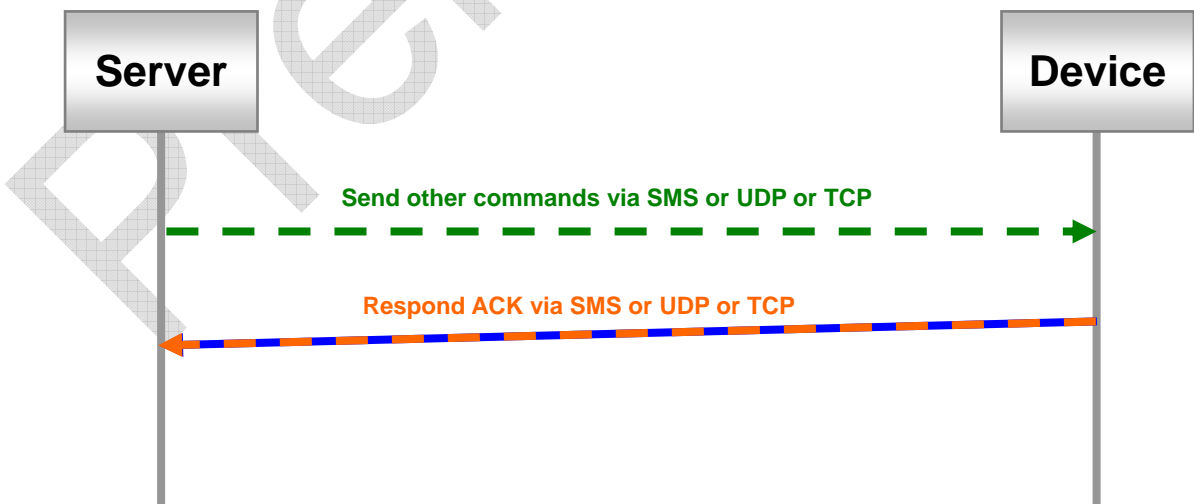

4.3 GPRS connection

If 'Rn' is set in moving state or 'Rf' is set in static state, then TR-600 will try to keep GPRS always on-line. The device will check the connection periodically. The period is defined by 'E5'. If the connection is lost, the device will try to connect again. If 'E6' is set, device will send "OK" message when connection is recovered.

If the connection is kept for a long time without sending any message, GSM carrier may terminate the connection intentionally. In some worst conditions, the carrier may even reject further request for connection. Setting of 'E4' is used to overcome this issue. TR-600 will disconnect and then re-connect after it has been on-line for the time defined by 'E4'.

If the "always on-line" setting is not set, TR-600 will establish GPRS connection when it wants to send UDP or TCP reports. After the report has been sent out, the device will keep GPRS connected for the interval defined by 'EA'. Server can send message to device in the interval and the connection will be extended further for 'EA' time.

In certain circumstance the server may want the device to setup GPRS connection for receiving command or configuration messages. 'L4' command is used to achieve the purpose. TR-600 will connect to server immediately when getting L4 command. After the connection is established, TR-600 will keep on-line for an interval defined by E7. Server can send commands or configure the device during the interval. If there's no message received during the interval, the connection will be terminated. If there is a message received in the interval, the connection will be extended for another E7 time. Server can send L5 command to terminate the connection immediately.

The related configuration parameters are listed in the table below.

Code word	Parameters	Value	Description
D8	Report Media for L4 command	02=TCP 04=UDP	Connection protocol for always on-line and "L4" command.
E4	Interval in on-line state for disconnecting and then re-connecting	u16, in seconds	0=disable

E5	Interval for checking if GPRS connection is on-line. If GPRS connection is cut, TR-600 will try to connect to server for one time.	u16, in seconds	0=disable
E6	Enable/disable TR-600 to send "OK" to server after GPRS connection is re-built.	1/0	0=disable 1=enable Available when E5 is not 0
E7	Timeout of L4 connection	u16, in seconds	>=2, default=30
EA	Time for keeping GPRS connection after sending report	u8, in seconds	>=2, default=2
Rf	Keep GPRS on-line in static state	0/1	0=disable 1=enable
Rn	Keep GPRS on-line in moving state	0/1	0=disable 1=enable

Command format:

GSC,IMEI,L4*Checksum!

Command Codeword	Parameters
L4	Connect to server

Example: Ask TR-600 to connect to server by TCP.

GSC,123456789012345,L4(D8=02)*5d!

5 GPS

In the general tracking modes, TR-600 will turn on GPS when it needs to generate a report. The pre-on time is controlled by C1 or C2, depending on last GPS fix is available or not. Since GPS is most power consuming module, the device will automatically turn off GPS when its information is not needed. You may set GPS always on if power consumption is not a critical issue.

There are some functions that depend on GPS information to work, such as

1. Report based on traveled distance in the motion report, sleeping report
2. Speed limit
3. Geo-fence
4. Data Logger

For those functions to work properly, GPS has to be turned on intentionally.

Code word	Parameter	Value	Description
C1	The time for starting to get GPS fix before the next report time if TR-600 does not get GPS fix in last report, or got GPS fix for 1 hour ago	u16, in seconds	60 ~ 600 Note: TR-600 will send out the report whether it gets GPS fix or not when C1 time ends.
C2	The time for starting to get GPS fix before the next report time if TR-600 got GPS fix within 1 hour	u16, in seconds	10 ~ 120 Note: TR-600 will send out the report whether it gets GPS fix or not when C2 time ends.
C3	GPS fix time before sending out the first report	u16, in seconds	0 ~ 600 If "C3"=0, disable first report message.
Rd	GPS always on in static state	1/0	0=disable 1=enable
RI	GPS always on in moving state	1/0	0=disable 1=enable

C1 example, the next report time is 10:00:00 and TR-600 does not get GPS fix in last report, C1 is 180 seconds. TR-600 will start to get GPS fix at 9:57:00 and send out report at 10:00:00.

C2 example, the next report time is 10:00:00 and TR-600 got GPS fix within 1 hour, C2 is 20 seconds. TR-600 will start to get GPS fix at 9:59:40 and send out report at 10:00:00.

C3 example, If C3=10 seconds and TR-600 is in the static state. When TR-600 is moved, it will switch to moving state and try to get GPS fix for 10 seconds. Then it sends motion moving report to notify the motion event.

Preliminary

6 Tracking

6.1 Ping Report

Ping function is for getting the present location and status of TR-600. The command is N1. Please set the tolerance time for TR-600 to get fixed before sending out the report by the parameter OS. TR-600 will turn on GPS once N1 command is received. If TR-600 gets GPS fix within OS time, it will send ping report as soon as it gets GPS fix. If it can not get GPS fix within the allowed time, it will send out the report at the end of OS time.

Code word	Parameters	Value	Description
OD	Report media for ping (N1) report	Media type	Please refer to section 2.9 Report media
OS	Longest time for GPS fix between receiving ping command and sending out ping (N1) report	u16, in seconds	If OS=0, GPS fix time=C3 Default=30

Command format:

GSC,IMEI,N1*Checksum!

Command Codeword	Parameters
N1	Ping device

Example 1: Ping TR-600 location and ask it to report via SMS no later than 20 seconds.

GSC,135785412249986,N1(OD=01,OS=20)*23!

6.2 Motion Report

TR-600 has built in a motion sensor to detect the movement or vibration. Using this feature, the device can work in moving state or static state. Each state has independent parameters to control the behavior.

Basically, TR-600 will send report and trigger action periodically according to the interval defined for the working state. You may set a short interval for moving state and a long interval for static state to save transmission fee.

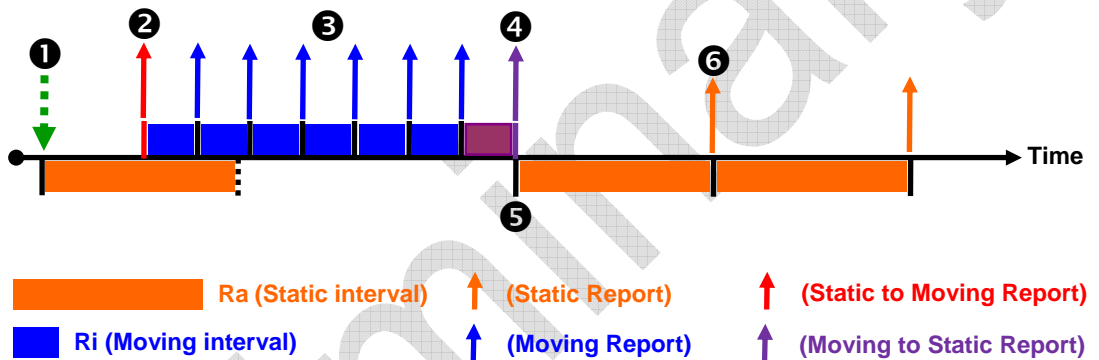

①	Static state report.
②	When TR-600 detects motion, it will enter moving state and send “static to moving” report.
③	Moving state report.
④	When TR-600 is static, it will send “moving to static” report and then return to the static state.
⑤	Re-start timer for static interval.
⑥	Static state report.

In both states, GPS can be configured to be always on for GPS related function to work properly. The device will terminate GPRS connection after sending reports. But you may set GPRS to be always on-line so that server can send message to device at any time. Please refer to section “4.3 GPRS connection” for the usage of always on-line connection.

GSM can be configured to be off in static state to save battery power. The device will turn GSM on to send report and then turn it off after report has been sent.

In moving state, the traveled distance can be considered to generate report as well as

report interval, whatever criterion is matched first. Then the report is sent and the device re-starts to check distance and interval. You may need to keep GPS on for this function to work. Please refer to “Chapter 5 GPS” for detail.

If the motion sensor is triggered by a short vibration pulse in static state, you may configure the device to watch for further vibration before switching to moving state. An intermediate state called validation state is used to confirm the movement. If the moving distance exceeds the threshold (R_w) within allowable time window (R_x), the device will switch to moving state. Otherwise it will return to static state. Validation state can be disabled by setting $R_w=0$.

Traveled distance can be used as a motion syndrome in moving state. If the traveled distance exceeds the threshold (R_p) within time window (R_y), the device will keep in moving state. Setting $R_p=0$ will disable the distance check.

You may configure parameters to send report and/or trigger action for state transition.

If report interval is set to 0, TR-600 will not send report. Action will not be triggered if action type is set to 00.

Parameter ‘ R_z ’ is used to control the sensitivity of motion sensor. The larger the value is, the less sensitive the sensor is. If $R_z=0$, the motion sensor is disabled and the device will be in static state.

The related parameters are listed below.

State	Code word	Parameters	Value	Description
Static state	Ra	Report interval in static state	u32, in seconds	1~4 Giga seconds
	Rb	Report Media in static state	Media type	Please refer to 2.9 Report media
	Rc	Action for static state	Action type	Please refer to 2.10 Action type
	Rd	GPS always on in static state	1/0	1=enable, 0=disable
	Re	Turn off GSM module in static state	1/0	0=turn on GSM 1=turn off GSM
	Rf	Keep GPRS on-line in static	1/0	Available when $R_e=0$

		state		0=disable 1=enable
Moving state	Ri	Report interval in moving state	u32, in seconds	3~4 Giga seconds
	Rj	Report Media in moving state	Media type	Please refer to 2.9 Report media
	Rk	Action for moving state	Action type	Please refer to 2.10 Action type
	RI	GPS always on in moving state	1/0	1=enable, 0=disable
	Rn	Keep GPRS on-line in moving state	1/0	0=disable 1=enable
	Ro	Traveled distance for sending report in moving state	0=disable 1~1000000 Unit: meter	
	Rp	Traveled distance to be judged as keeping in moving state	u16, Unit: meter	0=disable
Changing state	Rs	Report media for changing from static to moving state	Media type	Please refer to 2.9 Report media
	Rt	Report media for changing from moving to static state	Media type	Please refer to 2.9 Report media
	Ru	Action for changing from static to moving state	Action type	Please refer to 2.10 Action type
	Rv	Action for changing from moving to static state	Action type	Please refer to 2.10 Action type
	Rw	Minimum distance to be judged as moving state	u16, Unit: meter	0 ~ 65535 0=disable
	Rx	Interval for switching from validation to static state if no motion detected	u16, in seconds	0=Interval is the same with Ri
	Ry	Interval for switching from moving to static state if no motion detected	u16, in seconds	0=Interval is the same with Ri
	Rz	Motion sensor sensitivity	u16	0=disable Default=5

Example 1:

Set TR-600 motion report with report interval of 3600 seconds for static state (Ra), report interval of 30 for moving state (Ri) and report media of static state (Rb) TCP, report media of moving state (Rj) TCP

GSS,130158974523157,3,0,Ra=3600,Ri=30,Rb=02,Rj=02*5d!

Example 2:

Ask TR-600 to send TCP report periodically with interval=60 seconds, discarding the motion sensor.

GSS,130158974523157,3,0,Rz=0,Ra=60,Rb=02*55!

Example 3:

Set static report interval=7200 seconds, and turn off GSM at static state.

GSS,130158974523157,3,0, Ra=7200,Rb=02,Rc=00,Rd=0,Re=1,Rf=0*4a!

Preliminary

7. Alert

7.1 Emergency

When SOS (Emergency) button is hold and pressed over 2 seconds, The SOS flag of alarm status will be raised and TR-600 will start to send emergency reports by SMS and/or TCP/UDP with the interval defined by 'H2'.

The SMS reports can be configured to send to maximum 6 sets of phone numbers. The number of reports is defined by 'H1'. If you'd like to stop SOS report, please send "Na" command to TR-600.

Emergency report can also be sent to server by TCP or UDP. The number of report is defined by 'H3'. If H3 is set to zero, then the report will be sent continuously until the SOS flag is dismissed by server.

The related parameters are listed in the following table:

Code word	Parameters	Value	Description
G0	SMS Phone number 1	char(20)	
G1	SMS Phone number 2	char(20)	
G2	SMS Phone number 3	char(20)	
G3	SMS Phone number 4	char(20)	
G4	SMS Phone number 5	char(20)	
G5	SMS Phone number 6	char(20)	
H0	Report media		Please refer to 2.9 Report media
H1	Report number of SMS	u16	1 ~ 65535
H2	report interval	u16, in seconds	
H3	Report number of GPRS	u8	0=continue sending SOS alarm report till receive stop command

7.2 Speed Limits

TR-600 implements high speed alarm and low speed alarm. There're two parameters for the function to work. One is the speed limit (SA / SB). The other one is the hysteresis range. Once the speed alarm is detected, the alarm flag of alarm status is set, a report is sent and action is triggered. The alarm flag will be automatically dismissed if the alarm condition is disappeared. Speed alarm detection requires GPS information so the GPS should be turned on. Please refer to chapter "5. GPS" for the setting. Please refer to the illustrations below for the detection behavior.

High Speed Limit

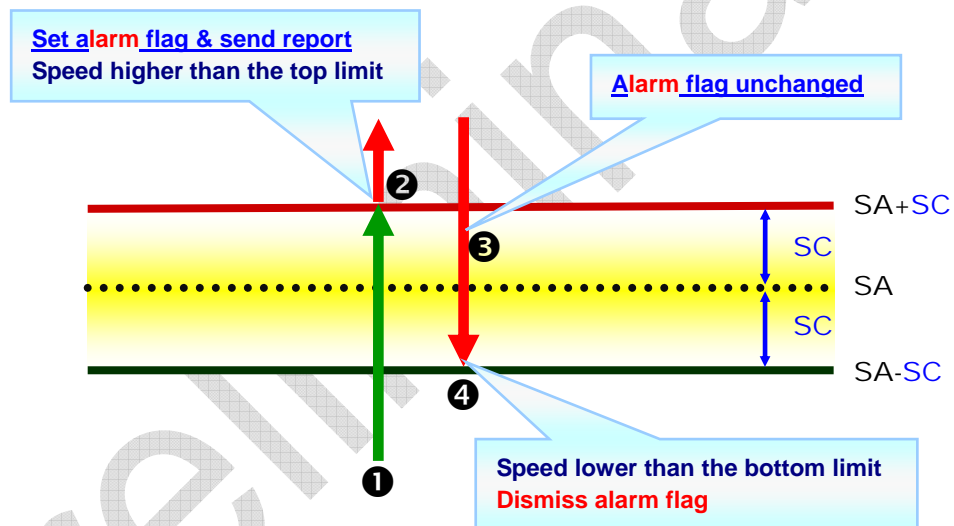

Low Speed Limit

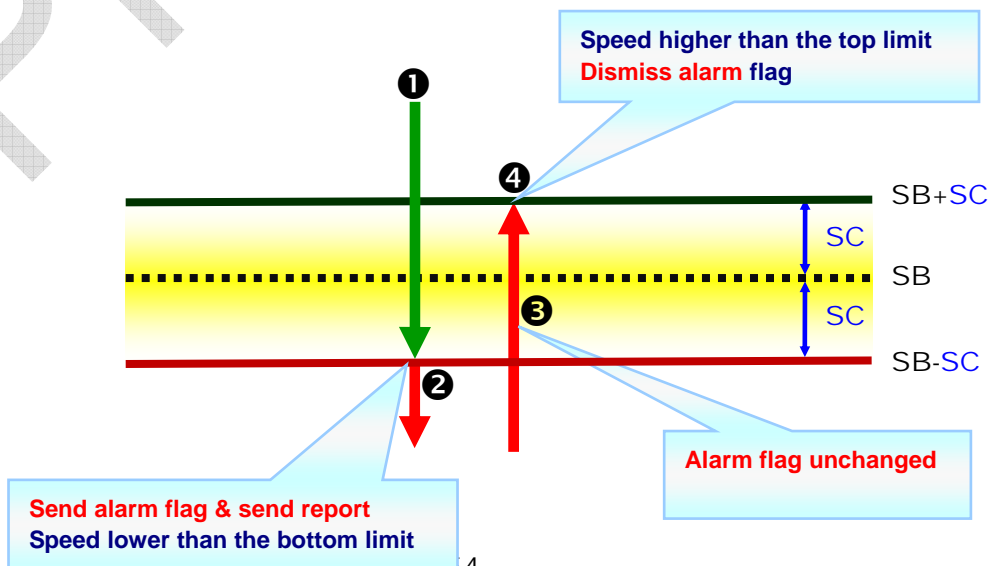

The parameters of speed alarm are listed below.

Code word	Parameters	Value
SA	Upper limit of speed alarm	u8, in Km/H 0 ~ 255 Km/H 0=disable
SB	Lower limit of speed alarm	u8, in Km/H 0 ~ 255 Km/H 0=disable
SC	Hysteresis of speed alarm	u8, in Km/H 0 ~ 255 Km/H
SD	Report media of speed alarm	Please refer to 2.9 Report media
SE	Action for high speed alarm	Please refer to 2.10 Action type.
SF	Action for low speed alarm	Please refer to 2.10 Action type.

7.2.1 Enable Speed Limit Alert

Example 1:

Set upper limit of speed alert

GSS,10339376540375,3,0,SA=105,SC=5,SD=02*65!

The behavior is as follows:

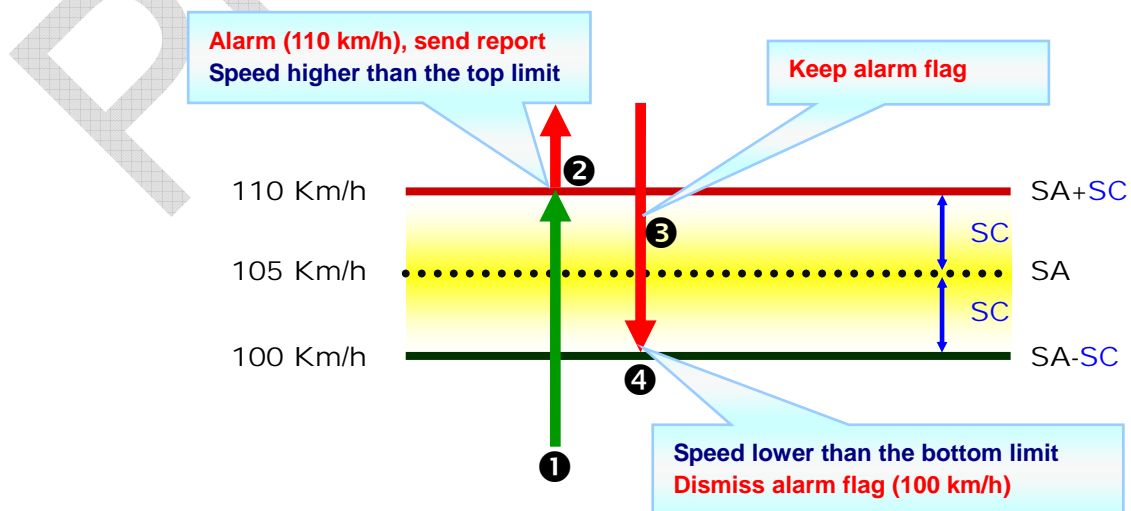

Example 2:

Set lower limit of speed alert (Send command via SMS or TCP or UDP)

GSS,10339376540375,3,0,SB=65,SC=5,SD=02*51!

The behavior is as follows:

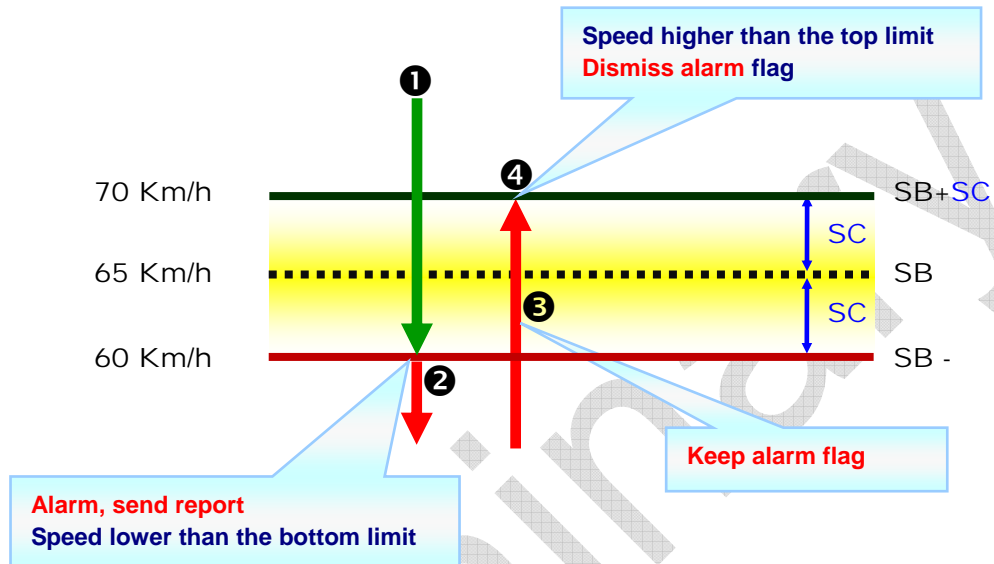

7.2.2 Disable Speed Limit Alert

Example 1:

Disable upper limit of speed alert

GSS,10339376540375,3,0,SA=0*51!

Example 2:

Disable lower limit of speed alert

GSS,10339376540375,3,0,SB=0*52!

7.3 Geo-fence

Geo-fence is for setting a rectangular area as permissible area or restricted area. When TR-600 gets out of the permissible area or goes in to the restricted area, TR-600 will send a report and/or trigger an action.

Geo-fence function needs the information of GPS to check with the settings. Please refer to chapter “5. GPS” for the setting.

TR-600 supports up to 64 sets of geo-fence areas. Each area could be configured and re-configured. For example, after you set 10 sets of geo-fence areas. You could change the 7th geo-fence area setting independently.

Geo-fence area with type=0 is disabled. You could disable any one of the previously set geo-fence area by setting it again and change the alert type to be 0. The alert types of geo-fence are illustrated below.

Alert type of Geo-fence				
1	2	3	4	5
Get in area	Get out of area	Cross over the boundary	Stay in area	Stay out of area

(upper_left_Lon,upper_left_Lat)

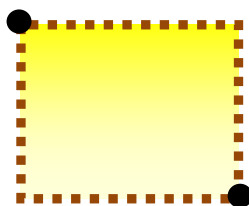

(right_bottom_Lon,right_bottom_Lat)

7.3.1 Setup Geo-fence

A Geo-fence area is defined by several parameters.

- Area ID
- Left (west) longitude, Top (north) latitude

- Right (east) longitude, Bottom (south) latitude
- Type
- Optional effective time window (start time, end time, weekday mask)

Message format for configuring Geo-fence area:

GSG,IMEI,T,S,id1=(type,upper_left_Lon,upper_left_Lat,right_bottom_Lon,right_bottom_Lat[,StartTime,EndTime,weekday]),id2=(...),id3=(...), ...*Checksum!

A complete geo-fence configuration message may be composed of several packets in sequence. All the area IDs in the message must be in ascending order.

'T' field in the message denotes the sequence control flag. Bit 0~2 represents start of message, end of message & erase setting respectively. For example:

'1': Start of message

'2': End of message

'3' : Start and End of message, i.e., only one packet for message



'5' : Erase all of the previously set geo-fence areas + start of message (when you need to set new geo-fence areas by more than 1 packet)

'7' : Erase all of the previously set geo-fence areas + start and end of message (when you need to set new geo-fence areas by only 1 packet)

Longitude & latitude are in the unit of 0.000001 degree. East longitude & north latitude are represented by positive numbers and the prefix '+' can be omitted. West longitude & south latitude are represented by negative numbers and the prefix '-' should be added.

Effective time window is an optional field. It specifies the effective time in a day and applicable day in a week. Start time & end time are in seconds counted from 12:00:00AM. Weekday mask is expressed by 2 hex digits with bit 0~6 represent Sunday ~Saturday respectively.

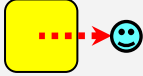
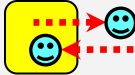
Format	Value	Note
GSG	"GSG" : Write geo-fence parameter command	Command head
IMEI	(The IMEI number)	GSM device ID
T	Bit 0 : Start of message	Message

	Bit 1 : End of message Bit 2 : Erase all of previous setting	packet control
S	'0','1','2','3',..., '9','10','11',..., '63'	Sequence number
id	'1' ~ '64'	Area ID
type	0=disable the area 1=get in area  2=get out of area  3=cross over the boundary  4=stay in area  5=stay out of area 	Alert type of Geo-fence
upper_left_Lon, upper_left_Lat	upper_left_Lon =Lon upper_left_Lat =Lat Lon: (+ or -)ddddddddd unit: 0.000001 degree Lat: (+ or -)ddddddddd unit: 0.000001 degree	The top left coordinates of specified area
right_bottom_Lon, right_bottom_Lat	right_bottom_Lon =Lon right_bottom_Lat =Lat Lon: (+ or -)ddddddddd unit: 0.000001 degree Lat: (+ or -)ddddddddd unit: 0.000001 degree Example: 12129141 12129141 x0.000001=12.129141 degree	The right bottom coordinates of specified area

Start Time	0~86399 sec Example: 00:00:01 = 1 23:59:59 = 86399	
End Time	1~86400 sec Example: 00:00:01 = 1 23:59:59 = 86399	
weekday	bit0=Sunday bit1=Monday bit2=Tuesday bit3=Wednesday bit4=Thursday bit5=Friday bit6=Saturday	
*	*	End of field
Checksum	The checksum value is derived by the same method of NMEA standard. It is calculated by 'exclusive OR' the 8 data bits of each character before "*" in the sentence, but excluding "*". The hexadecimal value of the most significant and least significant 4 bits of the result are converted to two ASCII characters (0-9, A-F) for transmission. The most significant character is transmitted first.	
!	!	Message delimiter

Example 1.1:

Set up 52nd ~57th sets of geo-fence areas

GSG,130738902846156,1,0,52=(2,121752441,24756536,121752924,24755863),53=(2,121743236,24748254,12174845,24744844)*78!

GSG,130738902846156,0,1,54=(1,121758267,24786053,121760745,24784397),55=(3,160053272,24144678,160056791,2414037)*73!

GSG,130738902846156,2,2,56=(1,160080072,24161526,160080866,24160439),57=(2,160075888,2410602,120722923,2406402)*47!

Example 1.2:

Disable the 56th set of geo-fence (by setting the alert type to be 0)

GSG,130738902846156,3,0,56=(0,160080072,24161526,160080866,24160439)*61!

Example 1.3.1:

Erase 52nd ~57th sets of geo-fence areas and set 2 geo-fence areas

GSG,130738902846156,7,0,1=(1,12146435,25009979,121466711,25008423),2=(1,121471624,25012487,121474736,25010756)*7C!

Example 1.3.2:

Erase 52nd ~57th sets of geo-fence areas and set 3 geo-fence areas

GSG,130738902846156,5,0,1=(1,12146435,25009979,121466711,25008423),2=(1,121471624,25012487,121474736,25010756)*7E!

GSG,130738902846156,2,1,3=(1,123479371,28016629,123148068,28015657)*55!

Example 2.1:

Set up 1st ~10th sets of Geo-fence areas

GSG,132763902812736,1,0,1=(1,121305521,24999088,121308246,24997649,00,86400,7f),2=(1,121302452,25004397,121305285,25002842)*0A!

GSG,132763902812736,0,1,3=(1,121299427,25014101,121302345,25012545),4=(1,121301723,25022909,121305306,25021101)*4F!

GSG,132763902812736,0,2,5=(1,12146435,25009979,121466711,25008423),6=(1,121471624,25012487,121474736,25010756)*54!

GSG,132763902812736,0,3,7=(1,121479371,25016629,12148068,25015657),8=(1,121547295,25043931,121548105,25043547)*7C!

GSG,132763902812736,2,4,9=(1,121536984,25049913,121538894,25048514),10=(1,121539195,25055901,121540675,25054773)*78!

Example 2.2:

change the 7th set of geo-fence area

GSG,132763902812736,3,0,7=(1,123479371,28016629,123148068,28015657)*5C!

7.3.2 Reading Geo-fence setting

Command of reading geo-fence data is 'L3' and the report media is defined by 'K4'.

Command Codeword	Parameters
L3	(id1,id2~id3,id4)

Example 1:

Read 1st ~10th Geo-fence areas

GSC,132763902812736,L3(1-10)*04!

Example 2:

Read Geo-fence area 1,2,5~8 & 10.

GSC,132763902812736,L3(1,2,5~8,10)*44!

Message format for reading Geo-fence area:

GSg,IMEI,T,S,id1=(type,upper_left_Lon,upper_left_Lat,right_bottom_Lon,right_bottom_Lat[,StartTime,EndTime,weekday]),id2=(...),id3=(...),...*
Checksum!

About the parameters of reading geo-fence, please refer to the parameters of setting geo-fence.

Example 1:

Report 1~5 coordinates of Geo-fence

GSg,132763902812736,1,0,1=(1,121305521,24999088,121308246,24997649,00,86400,7F),2=(1,121302452,25004397,121305285,25002842,00,86400,7F)*6D!

GSg,132763902812736,0,1,3=(1,121299427,25014101,121302345,25012545,00,86400,7F),4=(1,121301723,25022909,121305306,25021101,00,86400,7F)*6F!

GSg,132763902812736,2,2,5=(1,12146435,25009979,121466711,25008423,00,86400,02)*5f!

7.3.3 Enable Geo-fence Alert

Geo-fence is independent from other functions. It needs the information of GPS to check with the settings. So the GPS should be additionally turned on regardless of other reports. Please refer to chapter “5. GPS” for the setting.

After configuring the geo-fence areas, there must be an additional command ‘N6’ to turn on the function. It can be turned off by ‘N7’ command or by setting K0=0.

Codeword	Parameters	Value	Description
K0	Enable geo-fence	1/0	1=enable 0=disable (default)
K3	Report media of geo-fence alarm	Media type	Please refer to 2.9 report media.
K4	Report media of reading geo-fence area	Media type	Please refer to 2.9 report media.
K6	Action for geo-fence alarm	Action type	Please refer to 2.10 action type

Command’s format for enable/disable Geo-fence:

GSC,N6*Checksum!

Command Codeword	Function
N6	Enable Geo-fence
N7	Disable Geo-fence

Example 1:

Asking TR-600 enter geo-fence alert state and use timer 1: Start Time: 12:00:00AM (X0=0), End Time:11:59:59PM(X1=86399), Report Interval=0 (X2=0), Weekday: Sunday~ Saturday (X3=7f), Report Media: GPS ON(X4=80)

GSC,011412000010789,N6(X0=0,X1=86399,X2=0,X3=7f,X4=80)*2b!

Example 2:

Asking TR-600 disable geo-fence

GSC,135097652783615,N7*38!

7.3.4 Dismiss Geo-fence Alarm

TR-600 would send out only one geo-fence alarm report when it violates the geo-fence rule. The user should dismiss the alarm flag by “Ne” command and the monitoring of geo-fence will re-start. If geo-fence function is disabled by “N7” command, the alarm flag will also be cleared.

If you set the alert type of geo-fence as “stay in area” (type 4) or “stay out of area” (type 5), you could dismiss the geo-fence alarm to check if TR-600 still stay in the geo-fence area or stay out of the area. After dismissing the geo-fence alarm, if TR-600 still stays in the geo-fence area or stay out of the area, TR-600 would send a new report.

Command’s format for dismiss Geo-fence alarm status:

GSC,Ne*Checksum!

Command Codeword	Function
Ne	Dismiss Geo-fence Alarm

Example 1:

Dismiss TR-600 geo-fence alarm status

GSC,135097652783615,Ne*6A!

7.4 Autonomous Geo-fence

Autonomous geo-fence is independent from geo-fence. When the function is enabled, TR-600 will try to get GPS fix and make itself as the center of circle and draw a circle as the geo-fence area. When the device is moved out of the circle, autonomous geo-fence alarm flag of alarm status is set. Then TR-600 will send a report and/or trigger an action.

Please note that autonomous geo-fence will be automatically disabled once the alarm flag is triggered. It can be enabled again for a new geo-fence area.

The radius of the circle is defined by the parameter ‘K2’. You could activate autonomous geo-fence by the command Nk or by setting the parameter K1=1. You

could also deactivate autonomous geo-fence by the command NI or by setting the parameter K1=0.

Code word	Parameter	Value	Description
K1	Enable /disable autonomous geo-fence	1/0	1=enable autonomous geo-fence 0=disable autonomous geo-fence Default=0
K2	Autonomous geo-fence radius	u32, in meters	>=30, default=100
K3	Report media of geo-fence alarm	Media type	Please refer to 2.9 report media.
K7	Action for autonomous geo-fence alarm	Action type	Please refer to 2.10 action type

Example 1:

Enable autonomous geo-fence and set the radius as 1000 meters (K2=1000).
GSC,011412000010789,Nk(K2=1000)*06!

Example 2:

Disable autonomous geo-fence
GSC,011412000010789,NI*45!

Command's format for dismiss autonomous geo-fence alarm status:

GSC,Nm*Checksum!

Command Codeword	Parameters
Nm	Dismiss autonomous Geo-fence Alarm

Example 1:

Dismiss autonomous geo-fence alarm.

GSC,135097652783615,Nm*42!

7.5 ACC alert

ACC signal is a dedicated input that detects the power status of vehicle. Activation of ACC means the vehicle power is turned on. Once the status of ACC is changed, TR-600 will send report and/or trigger an action according to the setting of Qa, Qb, Qc & Qd.

If the report media is set to 00, there's no report sent.

If the action type is set to 00, there's no action triggered.

Code word	Parameter	Value	Description
Qa	Report media when ACC input is activated	Media type	Please refer to 2.9 report media.
Qb	Report media when ACC input goes inactive	Media type	Please refer to 2.9 report media.
Qc	Action when ACC input is activated	Action type	Please refer to 2.10 action type
Qd	Action when ACC input goes inactive	Action type	Please refer to 2.10 action type

Example 1:

Asking TR-600 to report by TCP(Qa=02, Qb=02) if ACC status is changed. Enable odometer when ACC input is activated (Qc=43). Disable odometer when ACC input goes inactive (Qd=42)

GSS,10339376540375,3,0,Qa=02,Qb=02,Qc=43,Qd=42*67!

7.6 Main battery alert

TR-600 will monitor the main battery continuously. Threshold of battery low is defined by J9. When main battery voltage is low or disconnected, it will send report and/or trigger an action according to the setting of J6, JA & JB.

Code word	Parameter	Value	Description
J6	Battery alarm report Media	Media type	bit0=SMS bit1=TCP bit2=UDP bit7=GPRS report format
J9	The power capacity for main battery power low alarm	u16, in mV	Default=11500
JA	The action for main battery disconnection alarm	Action type	Please refer to 2.10 action type
JB	The action for main battery power low alarm	Action type	Please refer to 2.10 action type

Premium

7.7 Parking Alert

When parking alert is enabled, TR-600 will monitor selected source for triggering parking alarm. The triggering sources include activation of digital input 1~3, detecting motion activity and activation of ACC input. The selected triggering source is defined by 'SJ', which is represented by 4 hex digits. One or more sources can be selected to trigger parking alarm.

If selected source is triggered, TR-600 will set parking alarm flag of alarm status, send a report or/and trigger an action. No further parking report or action will be generated until parking alert is enabled again. Parking alert is enabled by setting 'SI' to 1 or by simple command "PK=1"

Code word	Parameters	Value	Description
SI	Enable parking alert	1/0	0=disable 1=enable Default=0
SJ	Triggering source of parking alarm	xxxx (hex digits)	Bit 1=Din1 Bit 2=Din2 Bit 3=Din3 Bit 7=Motion Sensor Bit 13=ACC Default=2080
SL	Report media of parking alarm	Media type	Please refer to 2.9 report media
SK	Action type of parking alarm	Action type	Please refer to 2.10 action type

Example:

Enable parking alarm (SI=1) and set triggering source as motion sensor detects vibration (SJ=0080), set report type as TCP (SL=02)

GSS,10339376540375,3,0,SI=1,SJ=0080,SL=02*54!

Enable parking alarm (SI=1) and set triggering source as motion sensor detects vibration or ACC on (SJ=2080), set report type as UDP (SL=04)

GSS,10339376540375,3,0,SI=1,SJ=2080,SL=04*50!

8 Voice Monitor

Voice monitoring function is used to remotely hear the sound around the device by a voice phone call. You may call in the phone number of the device directly or ask the device to call out to specific phone number. Parameter V6 is used to control the orientation of the procedure.

The call in procedure is controlled by V4, V5, V6, V8 & V9. Only the phone numbers defined by V4, V8 & V9 are permitted to call in. The device will answer the phone call if the privileged phone number calls in within the interval (defined by V5) after the voice monitor function is enabled by N4 command.

The call out procedure is controlled by V4 & V6. If V6=1, the device will call out the phone number defined by V4 once N4 command is received.

A special condition for voice monitor is when SOS emergency alarm is triggered. You may ask TR-600 to call out SOS phone number 1 (G0) automatically if V0=1. If V0=0, the phone numbers defined by G0~G5 are permitted to call in within the time of V5 when SOS alarm is triggered.

The parameters of voice monitor are listed below.

Code word	Parameters	Value	Description
V0	Call out SOS phone number 1 when SOS alarm	1/0	0=disable 1=enable
V4	Call in/out phone number 1 for voice monitor	char(20)	
V5	Allowed interval for call in TR-600 after receiving voice monitor command	u16, in seconds	0 ~ 65535 Available when V6=0
V6	Call in or call out for voice monitor command	1/0	0=Call in 1=Call out
V8	Call in phone number 2 for voice monitor	char(20)	
V9	Call in phone number 3 for voice monitor	char(20)	

Command format:
GSC,N4*Checksum!

Command Codeword	Parameters
N4	Enable voice monitor

Example 1:

Make TR-600 call out (V6=1) the phone number of +886920886555 (V4=+886920886555) when receive the enable voice monitor command (N4)

GSC,130789246109245,N4(V4=+886920886555,V6=1)*29!

Example 2:

Make TR-600 wait the phone number +886920886555 (V4=+886920886555) or SOS phone number 1~6" phone number call in (V6=0) within 120 seconds (V5=120) when receiving the enable voice monitor command (N4)

GSC,130789246109245,N4(V4=+886920886555,V5=120,V6=0)*69!

Example 3:

Call out (V6=1) SOS phone number 1 when SOS alarm (V0=1)

GSS,011412000010789,3,0,V0=1*1e!

9 Timer

Timer can be used to send report or trigger events. There are four periodic timers for setting specified time report. The timers are effective during the time frame from start time to end time and the weekday defined by weekday mask. When start time is reached, the device enables the periodic timer with defined interval.

Start time and end time are counted in seconds from 12:00:00 AM. Weekday mask is used to define the effective days in a week. Bit 0 ~ bit 6 are used to activate the time on Sunday ~ Saturday respectively. If the bit is set, the timer is enabled on that appropriate day. Weekday mask is represented by 2 hex digits.

Timer 0 operates differently from other timers. When there is a new event (report), it will re-start to count down the report interval again.

Timer 1 ~ 3 will not count down the report interval when there is a new event.

9.1 Timer 0

The configuration parameters of timer 0 are listed below.

Code word	Parameters	Value	Description
W0	Start time	0~86399	
W1	End time	1~86400	
W2	Report interval	1~65535	
W3	Weekday mask	00~7f	u8, xx(hex digits)
W4	Report Media		Please refer to 2.9 Report media
W5	Action type		Please refer to 2.10 Action type.

9.2 Timer 1~3

The configuration parameters of timer 1~3 are listed below.

("X":Timer 1, "Y":Timer 2, "Z":Timer 3,)

Code word	Parameters	Value	Description
X0	Start time	0~86399	
X1	End time	1~86400	
X2	Report interval	1~65535	
X3	Weekday mask	00~7f	u8, xx(hex digits)
X4	Report Media		Please refer to 2.9 Report media
X5	Action type		Please refer to 2.10 Action type.
Y0	Start time	0~86399	
Y1	End time	1~86400	
Y2	Report interval	1~65535	
Y3	Weekday mask	00~7f	u8, xx(hex digits)
Y4	Report Media		Please refer to 2.9 Report media
Y5	Action type		Please refer to 2.10 Action type.
Z0	Start time	0~86399	
Z1	End time	1~86400	
Z2	Report interval	1~65535	
Z3	Weekday mask	00~7f	u8, xx(hex digits)
Z4	Report Media		Please refer to 2.9 Report media
Z5	Action type		Please refer to 2.10 Action type.

Example 1:

Make timer 3 to work from 8:00AM to 6:PM on Monday to Friday with interval=30 minutes.

GSS,123456789012345,3,0,Z0=28800,Z1=64800,Z2=1800,Z3=3e,Z4=02,Z5=00*0c!

10 Stopwatch

Stopwatch is a periodic timer started by command or triggered action. There are 4 stopwatches in total. Each stopwatch is controlled by 5 parameters (enable flag, interval, number of reports, report media and action type). It will stop if number of report is reached. If the number of report is set to 0, then the stopwatch can be terminated by stop stopwatch action or by configuration message.

The configuration parameters of stopwatch are listed below.

(“W”: Stopwatch 0, “X”: Stopwatch 1, “Y”: Stopwatch 2, “Z”: Stopwatch 3,)

Code word	Parameters	Value	Description
WA	Report interval	u32, in seconds	3~4 Giga
WB	Number of report	u8	0=continuous
WC	Report media	Media type	Please refer to 2.9 media type
WD	Action	Action type	Please refer to 2.10 Action type.
WE	Enable/disable stopwatch	1/0	0=disable stopwatch 1=enable stopwatch
XA	Report interval	u32, in seconds	3~4 Giga
XB	Number of report	u8	0=continuous
XC	Report media	Media type	Please refer to 2.9 media type
XD	Action	Action type	Please refer to 2.10 Action type.
XE	Enable/disable stopwatch	1/0	0=disable stopwatch 1=enable stopwatch
YA	Report interval	u32, in seconds	3~4 Giga
YB	Number of report	u8	0=continuous
YC	Report media	Media type	Please refer to 2.9 media type
YD	Action	Action type	Please refer to 2.10 Action type.

YE	Enable/disable stopwatch	1/0	0=disable stopwatch 1=enable stopwatch
ZA	Report interval	u32, in seconds	3~4 Giga
ZB	Number of report	u8	0=continuous
ZC	Report media	Media type	Please refer to 2.9 media type
ZD	Action	Action type	Please refer to 2.10 Action type.
ZE	Enable/disable stopwatch	1/0	0=disable stopwatch 1=enable stopwatch

Example 1:

Enable stopwatch 3 with interval=10 minutes, 4 reports, by UDP.

GSS,123456789012345,3,0,ZA=600,ZB=4,ZC=04,ZD=00,ZE=1*65!

11 Counter

TR-600 has implemented 4 software counters. Counter is for measuring the occurring times of particular event. When the counter value is accumulated to a threshold level, it will generate a counter event which would generate a report and/or trigger another action. If the “automatically reset counter” flag is set, the counter value will be reset to zero after the report/action.

If the trigger level of a counter is set to zero, then the counter will be disabled.

All events that have action type settings can be configured to increment or reset counter value. You may also use ‘Lc’ command to control the activity.

About the action type, please refer to “2.10 Action Type.”

Code word	Parameters	Value	Description
Pa	Occurring frequency for counter 0 to report/ make action	u32	0=no action/ report
Pb	Automatically reset counter 0	1/0	1=enable 0=disable
Pc	Report media of counter 0	Media type	Please refer to 2.9 media type
Pd	Action for counter 0	Action type	Please refer to 2.10 Action type.
Pg	Occurring frequency for counter 1 to report/ make action	u32	0=no action/ report
Ph	Automatically reset counter 1	1/0	1=enable 0=disable
Pi	Report media of counter 1	Media type	Please refer to 2.9 media type
Pj	Action for counter 1	Action type	Please refer to 2.10 Action type.
Pm	Occurring frequency for counter 2 to report/ make action	u32	0=no action/ report

Pn	Automatically reset counter 2	1/0	1=enable 0=disable
Po	Report media of counter 2	Media type	Please refer to 2.9 media type
Pp	Action for counter 2	Action type	Please refer to 2.10 Action type.
Ps	Occurring frequency for counter 3 to report/ make action	u32	0=no action/ report
Pt	Automatically reset counter 3	1/0	1=enable 0=disable
Pu	Report media of counter 3	Media type	Please refer to 2.9 media type
Pv	Action for counter 3	Action type	Please refer to 2.10 Action type.

Command format: GSC,IMEI,Lc(n,a)*Checksum!

Command Codeword	Parameters
Lc	Counter control : Lc(n,a) n=counter 0~3 a=0: clear counter a=1: increment counter

Example 1: Ask TR-600 to increment counter 0 (SE=A8) when the speed is over 70 km/hr. And when the speed is over 70 km/hr (SA=70) for 3 times (Pa=3), make counter 0 report via TCP (Pc=02).

GSS,10339376540375,3,0,SA=70,SE=A8,Pa=3,Pc=02*2b!

Example 2: Clear counter 1

GSC,10339376540375,Lc(1,0)*5e!

Example 3: Increment counter 3

GSC,10339376540375,Lc(3,1)*5d!

12 Odometer

Odometer is for measuring the traveled GPS distance of TR-600. It could be configured to generate a report and/or trigger an action when it has traveled for certain distance. The odometer can be enabled, disabled or cleared by 'Ld' command.

Note:

The traveled GPS distance is different from traveled geographical distance. The traveled distance of the tracker's odometer might not be the same with the traveled distance of your car's odometer.

Code word	Parameters	Value	Description
PA	Traveled GPS distance for odometer to report/ make action.	u32, in meters	
PC	Report media of odometer	Media type	bit0=SMS bit1=TCP bit2=UDP bit7=GPRS report format
PD	Action for odometer	Action type	Please refer to 2.10 Action type.
PE	Enable/disable odometer	1/0	0=disable 1=enable Default=1

Command format:

GSC,IMEI,Ld(C/D/E)*Checksum!

Command Codeword	Parameters
Ld	Odometer control (C)=clear, (D)=disable, (E)=enable

Example 1: Ask TR-600 to increment counter 0 (PD=A8) and report by TCP (PC=02) when the traveled distance of odometer is 10,000 meters (PA=10,000).

GSS,10339376540375,3,0,PE=1,PA=10000,PC=02,PD=A8*1a!

Example 2: Clear odometer

GSC,10339376540375,Ld(C)*37!

Example 3: Disable odometer

GSC,10339376540375,Ld(D)*30!

Example 4: Enable odometer

GSC,10339376540375,Ld(E)*31!

Preliminary

13 Report Messages

A report is generated by a specific event, such as ping, SOS alarm, digital input activated, etc. Each event has a corresponding report type and report media. Please refer to section 2.6 for the mapping of report type. The report media defines the report channel (TCP/UDP/SMS) and report format.

There are three types of GPRS report format, “format 0”, “format 1” and “format 2”. Typically format 0 is used for normal report which contains as much information as possible, and format 1 is used for heart beat report which contains necessary information to notify the server that the device is working properly.

Selection of report format 0/1 is defined in the report media setting for respective report condition. Please refer to section “2.9 Report media” for detail.

If GPS signal is blocked and the device can not get GPS fix when sending report format 0, format 2 is an alternative which contains GSM base station identifiers called “CELL ID”. Because the location of each GSM base station is fixed and known, “CELL ID” information can be used to calculate the approximate location of the device.

Format 0 and format 1 are configurable by setting O3 & ON respectively. But the format of format 2 is fixed.

There are two types of SMS messages. The first type is the same as GPRS report which is not friendly for reading. In order to overcome this drawback, the second type of SMS report is added for easy reading. The sentence and information of second type are all configurable.

13.1 Format 0 of Report Messages

Format 0 report is prefixed by “GSr”. Its content is configurable by setting parameter “O3”. Please refer to section 2.6 for the available report parameter and the respective codeword. Please collect the required codeword and put them together to form a string and set to “O3”. Then TR-600 will generate report according to the codeword sequence and translate to corresponding information.

Parameter's Codeword	Description
O3	Report format 0

(Refer to “2.6. Parameters of Report Messages” for details of parameters’ definition)

Example 1:

Set report format 0 by configuration message.

GSS,135785412249986,3,0,O3=SPRXAB27GHKLMn*U!*4d!

Then format 0 report will be in the following format.

GSr,IMEI,Alarm_Status,Report_Type,Variable_field,Geofence_status,GPS_Fix,UTC_Date,UTC_Time,Longitude,Latitude,Altitude,Speed,Heading,Number_of_Satellites,HDOP, Capacity of battery that presently supplied to TR-600*checksum!

For example:

GSr,135785412249986,01,I,EA02,,3,230410,153318,E12129.2839,N2459.8570,0,1.17,212,8,1.0,12.3V*55!

Example 2:

Ask TR-600 report “format of format 0” (Send command via SMS or TCP or UDP)

GSC,136647890362718,3,0,L1(O3)*6D!

TR-600 receives the command and reports the following message.

GSs,136647890362718,3,0,O3=SPRXAB27GHKLMn*U!*46!

13.2 Format 1 of Report Messages

Format 1 report is prefixed by “GSh”. Its content is configurable by setting parameter “ON”. Please refer to section 2.6 for the available report parameter and the respective codeword. Please collect the required codeword and put them together to form a string and set to “ON”. Then TR-600 will generate report according to the codeword sequence and translate to corresponding information.

Parameter's Codeword	Description
ON	Report format 1

(Refer to “2.6. Parameters of Report Messages” for details of parameters’ definition)

Example 1:

Set TR-600 format 1 of report by configuration message.

GSS,131826789036289,3,0,ON=SARY*U!*46!

Then format 1 report will be in the following format.

GSh,IMEI,GPS_Fix status,report type, joint I/O status*checksum!

For example:

GSh,131826789036289,3,M,ea04*3d!

Example 2:

Ask TR-600 report “format of format 1” (Send command via SMS or TCP or UDP)

GSC, 131826789036289,3,0,L1(ON)*36!

TR-600 receives the command and reports the following message

GSs,131826789036289,3,0,ON=SARY*U!*20!

13.3 Format 2 of Report Messages

GSM Cell ID is assisted information to get device location. When TR-600 does not get GPS fix, you could enable TR-600 to report the Cell ID information. Then the report format of TR-600 will automatically switch from format 0 to format 2 when TR-600 does not get GPS fix.

The parameter of enabling TR-600 to report the Cell ID is O8. Please note that report format 1 is not affected regardless of the setting of O8.

Code word	Parameters	Value	Description
O8	Enable/ disable TR-600 to report “cell ID” if it does not get GPS fix	1/0	0=disable 1=enable

The report format (format 2) of cell ID is

GSe,IMEI,Report_Type,Alarm_Status,X,Date,Time,

“MCC₁,MNC₁,LAC₁,CID₁,BSIC₁,RSSI₁”, “MCC₂,MNC₂,LAC₂,CID₂,BSIC₂,RSSI₂”,
 “MCC₃,MNC₃,LAC₃,CID₃,BSIC₃,RSSI₃”,...*checksum!

- MCC=mobile country code, 3 digits
- MNC=mobile network code, 2 or 3 digits
- LAC=location area code, 4 hexadecimal digits.
- CID=cell identifier, 4 hexadecimal digits.
- BSIC=base station identity code, 1 digit or 2 digits.
- RSSI=received signal strength indicator, 1 digit or 2 digits.

The number of set of cell information depends on GSM network environment.
 The maximum number is 5.

For example:

GSe,131826789036289,e,00,EA06,260110,103255,"466,92,0A8D,08C6,13,14","466,92,0A8D,2FD6,15,14","466,92,0A8D,466E,13,12","466,92,0A8D,6D7E,14,11","466,92,0A8C,E726,11,11"*16!

13.4 SMS Report

If the SMS flag of the report media is enabled when TR-600 is generating report, a SMS report will be sent to the phone number defined by F0. There're two types of SMS message. The first one is the same as GPRS messages described in the above sections. The second type is a configurable text which is designed for easy reading. Parameter 'F2' is used to control SMS message type.

Codeword	Parameters	Value	Description
F0	SMS return phone number	char(20)	
F2	SMS format 1	1/0	0= Same as GPRS format 1= Text format

For type 2 SMS report, each report type has a corresponding setting that defined the content of the SMS text. The setting is a combination of text and report parameter. A report parameter is represented by a leading '\$' and its codeword. For example, '\$A'

means GPS fix status. '\$+' represents a carriage return character. TR-600 will replace it by its value/status.

Note:

The leading "00" is necessary is necessary for format control. Please don't change or delete it.

The following table lists the related parameters for SMS report format settings. Please refer to "2.6. Parameters of Report Messages" for the codeword.

Code word	Parameters	Value	Default
BA	SMS format 1 report string for ping	char(96)	"00Ping report\$+IMEI:\$S\$+Time:\$C\$+GPS \$A\$+\$6,\$1\$+Speed:\$IK/H\$+IO:\$Y"
BB	SMS format 1 report string for SOS alarm	char(96)	"00Emergency!\$+IMEI:\$S\$+Time:\$C\$+GPS \$A\$+\$6,\$1\$+Speed:\$IK/H\$+IO:\$Y"
BC	SMS format 1 report string for GPS disconnection	char(96)	"00GPS ant. fail\$+IMEI:\$S\$+Time:\$C\$+GPS \$A\$+\$6,\$1\$+Speed:\$IK/H\$+IO:\$Y"
BD	SMS format 1 report string for ACC inactivation	char(96)	"00ACC off\$+IMEI:\$S\$+Time:\$C\$+GPS \$A\$+\$6,\$1\$+Speed:\$IK/H\$+IO:\$Y"
BE	SMS format 1 report string for ACC activation	char(96)	"00ACC on\$+IMEI:\$S\$+Time:\$C\$+GPS \$A\$+\$6,\$1\$+Speed:\$IK/H\$+IO:\$Y"
BF	SMS format 1 report string for digital input 1 inactivation	char(96)	"00DI 1 inactive\$+IMEI:\$S\$+Time:\$C\$+GPS \$A\$+\$6,\$1\$+Speed:\$IK/H\$+IO:\$Y"
BG	SMS format 1 report string for digital input 1 activation	char(96)	"00DI 1 active\$+IMEI:\$S\$+Time:\$C\$+GPS \$A\$+\$6,\$1\$+Speed:\$IK/H\$+IO:\$Y"
BH	SMS format 1 report string for digital input 2 inactivation	char(96)	"00DI 2 inactive\$+IMEI:\$S\$+Time:\$C\$+GPS \$A\$+\$6,\$1\$+Speed:\$IK/H\$+IO:\$Y"
BI	SMS format 1 report string for digital input	char(96)	"00DI 2 active\$+IMEI:\$S\$+Time:\$C\$+GPS \$A\$+\$6,\$1\$+Speed:\$IK/H\$+IO:\$Y"

	2 activation		
BJ	SMS format 1 report string for digital input 3 inactivation	char(96)	"00DI 3 inactive\$+IMEI:\$S\$+Time:\$C\$+GPS \$A\$+\$6,\$1\$+Speed:\$IK/H\$+IO:\$Y"
BK	SMS format 1 report string for digital input 3 activation	char(96)	"00DI 3 active\$+IMEI:\$S\$+Time:\$C\$+GPS \$A\$+\$6,\$1\$+Speed:\$IK/H\$+IO:\$Y"
BL	SMS format 1 report string for analog input	char(96)	"00Analog In:\$a\$+IMEI:\$S\$+Time:\$C\$+GPS \$A\$+\$6,\$1\$+Speed:\$IK/H\$+IO:\$Y"
BM	SMS format 1 report string for main battery disconnection	char(96)	"00Main Bat. lost\$+IMEI:\$S\$+Time:\$C\$+GPS \$A\$+\$6,\$1\$+Speed:\$IK/H\$+Backup:\$n"
BN	SMS format 1 report string for main battery low	char(96)	"00Main Bat. low\$+IMEI:\$S\$+Time:\$C\$+GPS \$A\$+\$6,\$1\$+Speed:\$IK/H\$+Backup:\$n"
BO	SMS format 1 report string for geo-fence alarm	char(96)	"00Geofence alarm\$+IMEI:\$S\$+Time:\$C\$+Area \$Z\$+\$6,\$1\$+Speed:\$IK/H\$+IO:\$Y"
BP	SMS format 1 report string for autonomous geo-fence alarm	char(96)	"00Parking fence alarm\$+IMEI:\$S\$+Time:\$C\$+GPS \$A\$+\$6,\$1\$+Speed:\$IK/H\$+IO:\$Y"
BQ	SMS format 1 report string for odometer	char(96)	"00Moving dist. \$i\$+IMEI:\$S\$+Time:\$C\$+GPS \$A\$+\$6,\$1\$+Speed:\$IK/H\$+IO:\$Y"
BR	SMS format 1 report string for counter 0	char(96)	"00Counter 0:\$e\$+IMEI:\$S\$+Time:\$C\$+GPS \$A\$+\$6,\$1\$+Speed:\$IK/H\$+IO:\$Y"
BS	SMS format 1 report string for counter 1	char(96)	"00Counter 1:\$e\$+IMEI:\$S\$+Time:\$C\$+GPS \$A\$+\$6,\$1\$+Speed:\$IK/H\$+IO:\$Y"
BT	SMS format 1 report string for counter 2	char(96)	"00Counter 2:\$e\$+IMEI:\$S\$+Time:\$C\$+GPS \$A\$+\$6,\$1\$+Speed:\$IK/H\$+IO:\$Y"
BU	SMS format 1 report string for counter 3	char(96)	"00Counter 3:\$e\$+IMEI:\$S\$+Time:\$C\$+GPS \$A\$+\$6,\$1\$+Speed:\$IK/H\$+IO:\$Y"

BV	SMS format 1 report string for static state of motion mode	char(96)	"00Static report\$+IMEI:\$S\$+Time:\$C\$+GPS \$A\$+\$6,\$1\$+Speed:\$IK/H\$+IO:\$Y"
BW	SMS format 1 report string for moving state of motion mode	char(96)	"00Moving report\$+IMEI:\$S\$+Time:\$C\$+GPS \$A\$+\$6,\$1\$+Speed:\$IK/H\$+IO:\$Y"
BX	SMS format 1 report string for changing from static to moving state	char(96)	"00Start moving\$+IMEI:\$S\$+Time:\$C\$+GPS \$A\$+\$6,\$1\$+Speed:\$IK/H\$+IO:\$Y"
BY	SMS format 1 report string for changing from moving to static state	char(96)	"00Stop moving\$+IMEI:\$S\$+Time:\$C\$+GPS \$A\$+\$6,\$1\$+Speed:\$IK/H\$+IO:\$Y"
Ba	SMS format 1 report string for high speed alarm	char(96)	"00Over speed!\$+IMEI:\$S\$+Time:\$C\$+GPS \$A\$+\$6,\$1\$+Speed:\$IK/H\$+IO:\$Y"
Bb	SMS format 1 report string for low speed alarm	char(96)	"00Under speed!\$+IMEI:\$S\$+Time:\$C\$+GPS \$A\$+\$6,\$1\$+Speed:\$IK/H\$+IO:\$Y"
Bc	SMS format 1 report string for timer 0	char(96)	"00Timer 0 alarm\$+IMEI:\$S\$+Time:\$C\$+GPS \$A\$+\$6,\$1\$+Speed:\$IK/H\$+IO:\$Y"
Bd	SMS format 1 report string for timer 1	char(96)	"00Timer 1 alarm\$+IMEI:\$S\$+Time:\$C\$+GPS \$A\$+\$6,\$1\$+Speed:\$IK/H\$+IO:\$Y"
Be	SMS format 1 report string for timer 2	char(96)	"00Timer 2 alarm\$+IMEI:\$S\$+Time:\$C\$+GPS \$A\$+\$6,\$1\$+Speed:\$IK/H\$+IO:\$Y"
Bf	SMS format 1 report string for timer 3	char(96)	"00Timer 3 alarm\$+IMEI:\$S\$+Time:\$C\$+GPS \$A\$+\$6,\$1\$+Speed:\$IK/H\$+IO:\$Y"
Bg	SMS format 1 report string for stopwatch 0	char(96)	"00Stopwatch 0 alarm\$+IMEI:\$S\$+Time:\$C\$+GPS \$A\$+\$6,\$1\$+Speed:\$IK/H\$+IO:\$Y"
Bh	SMS format 1 report string for stopwatch 1	char(96)	"00Stopwatch 1 alarm\$+IMEI:\$S\$+Time:\$C\$+GPS \$A\$+\$6,\$1\$+Speed:\$IK/H\$+IO:\$Y"

Bi	SMS format 1 report string for stopwatch 2	char(96)	"00Stopwatch 2 alarm\$+IMEI:\$S\$+Time:\$C\$+GPS \$A\$+\$6,\$1\$+Speed:\$IK/H\$+IO:\$Y"
Bj	SMS format 1 report string for stopwatch 3	char(96)	"00Stopwatch 3 alarm\$+IMEI:\$S\$+Time:\$C\$+GPS \$A\$+\$6,\$1\$+Speed:\$IK/H\$+IO:\$Y"
Bk	SMS format 1 report string for parking alarm report	char(96)	"00Parking alarm\$+IMEI:\$S\$+Time:\$C\$+GPS \$A\$+\$6,\$1\$+Speed:\$IK/H\$+IO:\$Y"

Example:

Ping report 'BA':

"00Ping report\$+IMEI:\$S\$+Time:\$C\$+GPS\$A\$+\$6,\$1\$+Speed:\$IK/H\$+IO:\$Y"

S=IMEI

C=Local date, time

A=GPS fix status

6=latitude

1=longitude

I=speed (K/H)

Y=joint I/O status

Then the received SMS is of the following format.

Ping report
IMEI:12345678901234
Time:311210,235959
GPS:3D fix
N21.924598,E100.314536
Speed:18 K/H
IO:e280

14 Data Log

The function of Data Log is used to record the GPS location information in TR-600. The recording criteria may based on time interval or/and traveled distance. If traveled distance criterion is selected, GPS must be turned on to calculate the moving distance. If both criteria are applied, then the device will save one record if any one of the criteria is matched and resets the counting.

If you want TR-600 to store position according to traveled distance, you have to extra make GPS on. Please refer to “Chapter 5 GPS.”

The recorded information can be uploaded to PC by RS-232 interface or be transmitted to server by GPRS remotely.

To enable data log function, you should configure parameters ‘O2’ & ‘OH’ and send ‘N8’ command. Command ‘N9’ is used to disable the function. The related parameters are listed below.

Codeword	Parameters	Value	Description
O2	Data logger interval	u16, in seconds	0 ~ 65535 0=disable
OH	Data logger distance	u32, in meters	0 ~ 4 Giga 0=disable

Command Codeword	Parameters
N8	Enable Data logger
N9	Disable data logger

Example 1:
 Enable data log function with 10 seconds interval.
 GSC,123456789012345,N8(O2=10)*51!

Example 2:
 Enable data log function with 2 minutes interval, maximum distance=100m & GPS always on.
 GSC, 123456789012345,N8(O2=120,OH=100,RI=1)*7a!

15 Buffer Storage

When TR-600 is carried to the areas without GSM/GPRS signal coverage, TR-600 could not send reports to server. In order not to lose the location report, TR-600 will save the location reports during the periods without GSM/GPRS signal to buffer storage. When TR-600 is moved to the areas with GSM/GPRS signal, it will retrieve the reports in the buffer storage and send them to server. TR-600 could save up to 1400 pieces of location reports to buffer storage.

The behavior is illustrated as following.

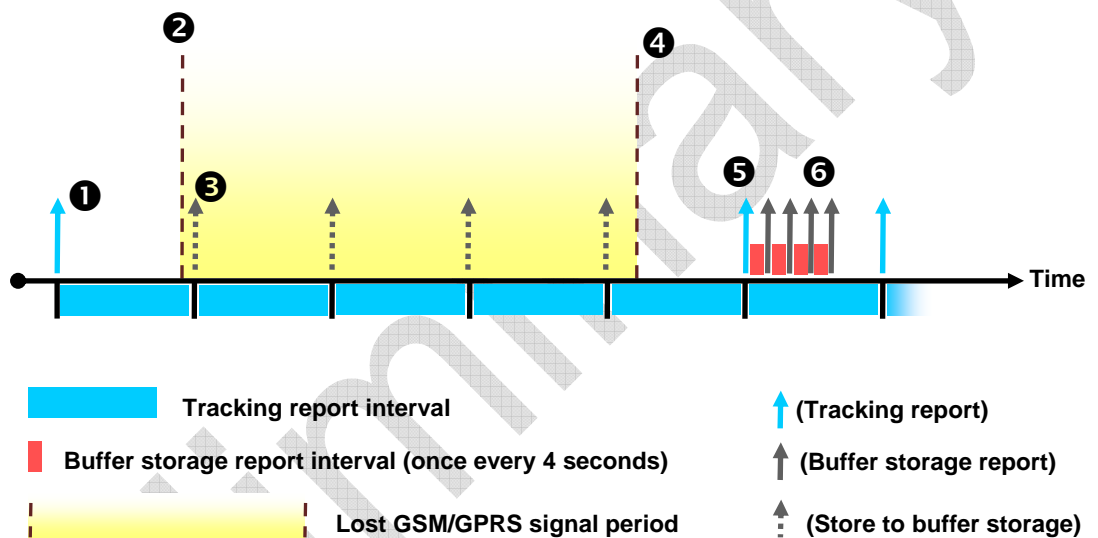

①	Send tracking report
②	Enter area without GSM/GPRS signal coverage.
③	Save location report to buffer storage
④	Enter area with GSM/GPRS signal
⑤	Send tracking report
⑥	Send the location report in the buffer storage

The parameter of enable data buffer function is OG.

Code word	Parameters	Value	Description
OG	Enable/ disable buffer storage function	1/0	0=disable 1=enable (default)

16 I/O port

TR-600 has 1 analog input, 3 digital inputs and 3 digital outputs. Analog input is used to measure the value of an analog sensor such as temperature sensor. Digital inputs are positive or negative trigger. They can be connected to sensor output such as door lock switch. Digital outputs are all active low. They can be used to control other devices such as the power relay of a refrigerator.

The wiring diagram is depicted below.

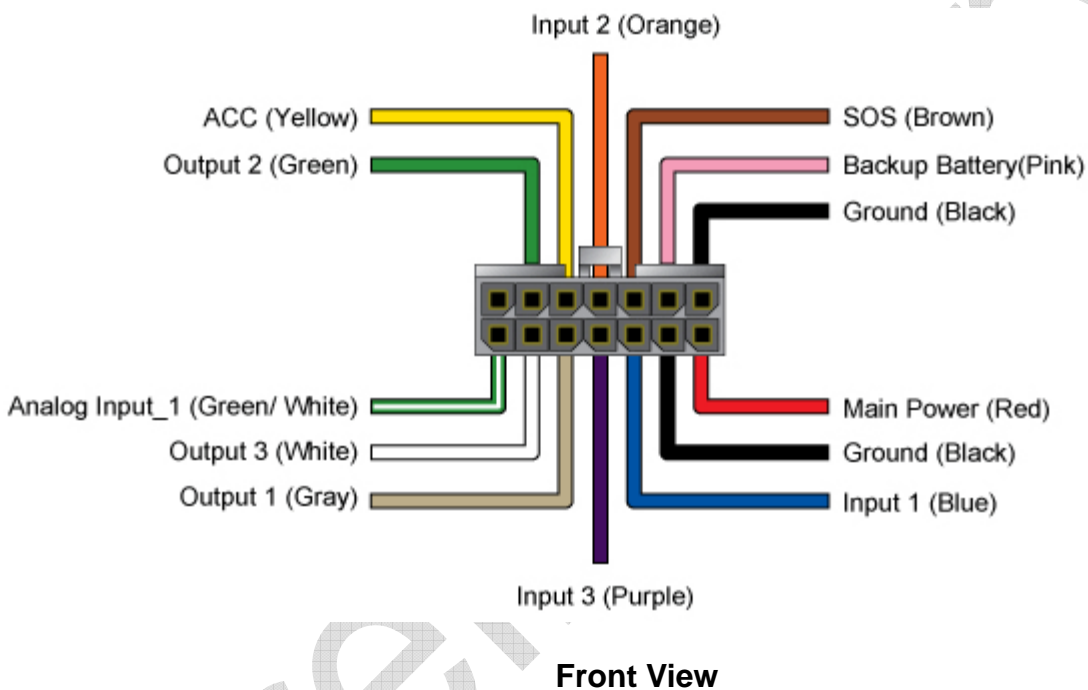

Wire Color	Description
Green/ White	Analog Input_1
White	Digital Output 3 (Negative Trigger)
Gray	Digital Output 1 (Negative Trigger)
Purple	Digital Input 3 (Positive Trigger)
Blue	Digital Input 1 (Negative Trigger)
Black	Ground
Red	Main Power
Green	Digital Output 2 (Negative Trigger)
Yellow	ACC (Positive Trigger)
Orange	Digital Input 2 (Negative Trigger)
Brown	SOS (Negative Trigger)

Pink	12V/24V Backup Battery
Black	Ground

8 Pin RS-232 Cable

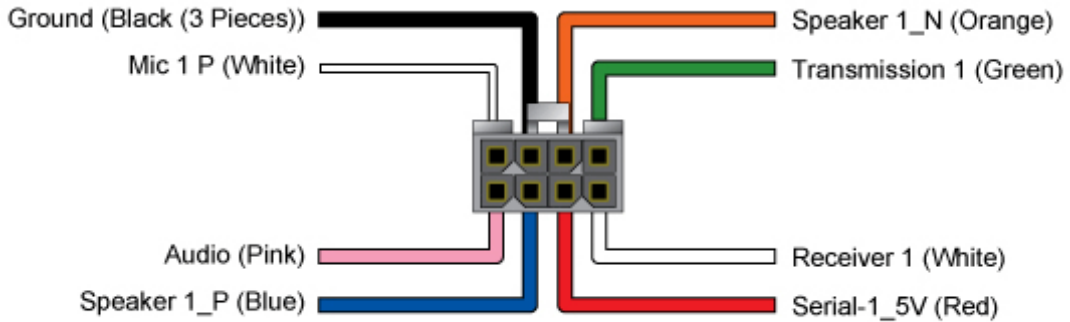

Wire Color	Description
Pink	Audio_5V
Blue	Speaker 1(Positive)
Red	Serial-1_5V
White	Receiver 1
White	Microphone 1 P
Black	(3 Pieces) Ground
Orange	Speaker 1(Negative)
Green	Transmission 1

16.1 Analog input

TR-600 can be configured to check the analog input periodically. If the reading exceeds or undergoes a threshold, then the device will generate a report and/or trigger an action. The related configuration parameters are listed in the table below.

Code word	Parameters	Value	Description
QA	Upper threshold of analog input	u16, in m V	

QB	Lower threshold of analog input	u16, in m V	
QC	Report media of analog input	Media type	Please refer to “2.9 report media.”
QD	Action for analog input	Action type	Please refer to “2.10 action type.”
QE	Check interval	u16, in seconds	0=disable

Example:

Set check interval to 10 seconds. Generate report and deactivate digital output 2 if analog input exceeds 5.7V.

GSS,123456789012345,3,0,QA=5700,QC=04,QD=C2,QE=10*2d!

16.2 Digital input

Digital input 1 and digital input 2 are negative triggered. Digital input 3 is positive triggered. You could set TR-600 to make report and/or action when digital input is activated or inactive. The related configuration parameters are listed below.

Code word	Parameters	Value	Description
Qg	Report media when digital input is activated	Media type	Please refer to “2.9 report media.”
Qh	Report media when digital input goes inactive	Media type	Please refer to “2.9 report media.”
Qi	Action when digital input is activated	Action type	Please refer to “2.10 action type.”
Qj	Action when digital input goes inactive	Action type	Please refer to “2.10 action type.”
Qm	Report media when digital input is activated	Media type	Please refer to “2.9 report media.”

Qn	Report media when digital input goes inactive	Media type	Please refer to “2.9 report media.”
Qo	Action when digital input is activated	Action type	Please refer to “2.10 action type.”
Qp	Action when digital input goes inactive	Action type	Please refer to “2.10 action type.”
Qs	Report media when digital input is activated	Media type	Please refer to “2.9 report media.”
Qt	Report media when digital input goes inactive	Media type	Please refer to “2.9 report media.”
Qu	Action when digital input is activated	Action type	Please refer to “2.10 action type.”
Qv	Action when digital input goes inactive	Action type	Please refer to “2.10 action type.”
Qy	Digital input status	xx(hex digit)	Read only. See note below.

Note: ‘Qy’ is a read only flag which collect all the status of all digital inputs. It is represented by 2 hex digits. Bit 1~3 reflect the status of digital input 1~3 respectively. If the bit is set, it means the input is in active triggered.

Example:

Generate report when digital input goes active.

GSS,123456789012345,3,0,Qg=04,Qi=00,Qh=00,Qj=00*50!

16.3 Digital output

The 3 digital outputs are all negative triggered. Their states can be changed by the triggered action of events or by ‘Lo’ command. You could read or set the digital output status by the parameter Qz.

Codeword	Parameters	Value	Description
Qz	Digital output status	xx(hex digit)	

Command format

GSC,IMEI,Lo(n,a)*checksum!

n=1~3 (digital output1~3) a:0=deactivate, 1=activate

Example: Activate digital output 1

GSC,12345678901234,Lo(1,1)*5c!

Example: Deactivate digital output 2

GSC,12345678901234,Lo(2,0)*5e!

Preliminary

17 Simple command

Typical command of TR-600 is composed of command code words, parameters & checksum. The code words are hard to remember and you may need a tool to generate the checksum. The purpose of simple command is to simplify the command format and send command without checksum. You could send simple commands to TR-206 by mobile phone's SMS.

The simple commands are “ping TR-600”, “TR-600 motion report”, “Control digital output”, “Voice monitor”, “Link to server”, “Autonomous geo-fence”, “Parking alert”, and “Reset device.”

For ping command, you could set the tolerance time of GPS fix.

For motion report, you could set the static report interval and the moving report interval. So there are two simple commands for TR-600 to switch to motion report, one is “MM” for setting moving report interval, and the other is “MS” for setting static report interval. The unit of the simple command's concerning parameters is second.

For voice monitor, you could set the call out phone number.

For autonomous geo-fence, you could activate or deactivate the function. The default radius of geo-fence area is 100 meters. You could set the radius of the geo-fence area by adding the value after the code word and equal mark. The unit of radius is meter. It must be greater than 30 meters.

For controlling the digital output1~3, you could activate or deactivate digital output 1~3.

For parking alert, you could activate or deactivate parking alert.

The simple commands could be optionally added with the equal mark and the concerning parameters. If you do not add parameters with the simple command, TR-600 will take the present setting as the setting.

Below please find the table of simple command.

Command	Code Word	Concerning Parameter
Ping	PI	[=tolerance time of GPS fix]
Motion moving	MM	[=moving report interval]

Motion static	MS	[=static report interval]
Control digital output1~3	DO1 DO2 DO3	=1 → activate =0 → deactivate
Autonomous geo-fence	AG	[=XXX → activate and set the radius] (XXX must be greater than 30.) =0 → deactivate
Link Server	LI	
Voice monitor	VM	[=call out phone number]
Parking alert	PK	=1 → activate =0 → deactivate
Reset device	RS	

Note:

1. To enable the simple command, please make the parameter A5=1. For example, GSS,011412000010789,3,1,A5=1*2d!
2. You could send several simple commands in one SMS. The simple command is separated by the "comma." Do not keep any blanks between the commas. Otherwise, TR-600 could not distinguish what is the command.
3. The simple commands must be capital case.

Command format:

“password,simple command 1,simple command 2,simple command 3, ...”

In order to protect the privacy, the simple command had better be followed after the password.

The parameter of setting simple command’s password is “Oa.” If you want to cancel the password, you could set Oa to be blank.

For example, set the password to be “VICTORY” for TR-600 whose IMEI is 011412000010789.

The command is “GSS,011412000010789,3,1,Oa=VICTORY*2a!”

For example, cancel the password of TR-600 whose IMEI is 011412000010789.

The command is GSS,011412000010789,3,1,Oa=*5b!”

Example 1, ping TR-600 and set the tolerance time of GPS fix as 3 minutes. The password is 520JX

The command is “520JX,PI=180”

Example 2, switch TR-600 to motion mode and set the moving report interval as 30 seconds and static report interval as 30 minutes. The password is 7777.

The command is “7777,MM=30,MS=1800”

Example 3, make TR-600 call 0920777777 to do voice monitor. There is no password.

The command is “VM=0920777777.”

Example 4, make TR-600 link to server. And there is no password.

The command is “LI”

Example 5, activate digital output 1. And there is no password.

The command is “DO1=1”

Example 6, deactivate digital output 3. And the password is JLTW.

The command is “JLTW,DO3=0”

Example 7, activate autonomous geo-fence and set radius as 3 kilometers. And the password is TWLG.

The command is “TWLG,AG=3000”

Example 8, activate autonomous geo-fence and use the present setting of radius. And there is no password.

The command is “AG”

Example 9, deactivate autonomous geo-fence. And the password is praise.

The command is “praise,AG=0”