FLEETPC- ARM-300 Series

Quick Start Guide

Release Notes

Version	Release Date	Notes
1.0	January , 2017	Initial release

Disclaimer

This documentation is provided for use with CarTFT.com products. No license to CarTFT.com property right is granted. CarTFT.com assumes no liability, provides no warranty either expressed or implied relating to the usage, or intellectual property right infringement that may result from its use.

CarTFT.com provides this document without any warranty of any kind, expressed or implied, including, but not limited to, its particular purpose. CarTFT.com may make changes to this document without notice.

Table of Contents

1	PRECAUTIONS	5
1.1	Safety Precautions.....	5
1.2	Write Prohibited Regions.....	6
1.3	Warranty	6
2	OVERVIEW	7
2.1	FLEETPC-ARM-300 Package Contents.....	8
2.2	FLEETPC-ARM-300 Connectors	9
	3 FLEETPC-ARM-300 INSTALLATION	10
3.1	Basic Installation	11
3.2	Full Installation	14
3.3	Remote Access	14
	APPENDIX A: FLEETPC-ARM-300 DEVICE MANAGER	15
A-1	GPS function.....	16
A-2	GPIO function	17
A-3	3-Axis G-sensor Data	18
A-4	E-compass function.....	19
A-5	System Date & Time.....	20
A-6	System Monitor	21
A-7	System Parameter setup.....	22
A-8	Setting Password	24
A-9	Setting Network.....	25
A-10	Setting WiFi.....	26
A-11	wcdma monitor	27
	APPENDIX B: OPENGTS INSTALLATION (WINDOWS)	28
B-1	Hardware Requirements	28
B-2	Software Requirements	28
B-3	Steps to Install OpenGTS	28
	APPENDIX C: OPENGTS INSTALLATION (LINUX).....	34
C-1	Host Computer.....	34
C-2	OpenGTS Installation procedures.....	34
C-3	Change OpenGTS map provider to Google Map	37

APPENDIX D: FLEETPC-ARM-300 REMOTE ACCESS

..... **38**

D-1 Access FLEETPC-ARM-300 from a remote Ubuntu PC

..... 39

D-2 Access FLEETPC-ARM-300 from a remote Widows PC
..... 42

1 Precautions

1.1 Safety Precautions

In order to use this product safely, please take special note of the following precautions.

- Read all product manuals and related documentation before using this product. Use this product correctly and safely. Follow all warnings.
- If operating or extending this product in a manner not described in this manual, please do so at your own risk. Be sure to fully read this manual and other technical information on our website and proceed safely and responsibly.
- Do not install this product in a place with a lot of water, moisture, dust or soot. This could cause product failure, fire, or an electric shock.
- Some parts of this product generate heat and can reach high temperatures. This may cause burns if it is improperly handled. Do not touch the electronic components or surrounding area while powered on or immediately after being turned off.
- Carry out any design and development only after you have thoroughly read and understood this manual and any other related technical materials on the website or in the data sheets. Test your product thoroughly for reliability and safety.
- This product is not intended for applications that require extremely high reliability, safety, functionality and accuracy: including but not limited to medical equipment, traffic control systems, combustion control systems, and safety equipment. This company is not liable for death or injury if used in such systems.
- This product uses semiconductor components designed for generic electronics equipment such as office automation, communications, measurement equipment and machine tools. Foreign noise or a power surge may cause this product to malfunction or fail.
- To ensure there is no risk of bodily harm or property damage, be sure to take all electrical safety precautions such as protection circuits, limit switches, fuse breakers, or redundant systems. Only use the device after sufficient reliability and safety measures are in place.

1.2 Write Prohibited Regions

Data stored by the EEPROM, i.MX6 electrical fuse (e-Fuse) is used by the software contained in this product. Do not write to these regions as this may cause the product stop working correctly. Purposely writing to these regions voids the product warranty.

1.3 Warranty

As described in the Product Warranty Policy provided with this product, the main board is covered by a one year replacement warranty starting from the time of purchase. Please note that the other included goods and software are not covered under this warranty. Some knowledge used by CARTFT.COM is provided by third parties, and CARTFT.COM makes no representation or warranty as to the accuracy of such information.

2 Overview

The FLEETPC-ARM-300 is a communication gateway designed for in-vehicle applications or IOT (Internet of Things) applications. The FLEETPC-ARM-300 offers some unique features, including the latest NXP iMX6 (ARM Cortex-A9) quad or dual cores application processor, an LTE modem socket with dual-sim card holder, a ublox GPS receiver, G-sensors, and software controlled power on/off.

With the latest Android/Linux kernel and tools, the FLEETPC-ARM-300 allows users to design and deploy custom software for various applications, such as vehicle tracking, fleet management and IOT communication gateway.

Features

- ARM Cortex processor with Android/Linux enables quick software development
- 9-36V wide input voltage range for vehicle application
- Photo-coupled GPIO for vehicle sensor input monitoring
- Sample OpenGTS server software for remote server demonstration

Hardware Specifications

- NXP iMX6 ARM Cortex™-A9 core @ 1GHz (quad-core, dual-core, single-core)
- 2GB (or 1GB) DDR3 + 4GB eMMC Flash
- 9V-36V DC power input
- **(optional)** DC power input with over-voltage protection
- USB 2.0 host port x2 + USB 2.0 OTG port x1 + Micro SD card socket x1
- Ublox GPS receiver x1
- miniPCI-e Connector + SIM card holder x2
- 3-Axis G-sensor x1 + E-compass x1
- Isolated RS485 x1 + Isolated RS232 x1 + Isolated CAN bus x 2 + I²C port x1
- Isolated digital input x 10 + Isolated digital output x 2
- 10/100/1000 Mbps Ethernet (RJ-45) x1
- 802.11a/b/g/n/ac WiFi x1 + Bluetooth 4.2 x1
- mSATA Connector x1
- 3G/LTE modem module **(optional)**
- Audio (MIC and Headphone) **(optional)**
- Dimension: 136mm x 204mm x 48mm (L x W x H)

Software Specifications

- Yocto 1.6 (or later)
- Android 6.0 (or later)

2.1 FLEETPC-ARM-300 Package Contents

Standard package content:

Item	Notes
FLEETPC-ARM-300 device	---
CD	Software and User's Manual

Optional items:

Item	Notes
+12V Power adapter	---
WiFi Antenna	---
LTE Module	---
GPS Antenna	---
3G/LTE Antenna	---
C220 debug board/cables	For FLEETPC-ARM-300 console, debug port

2.2 FLEETPC-ARM-300 Connectors

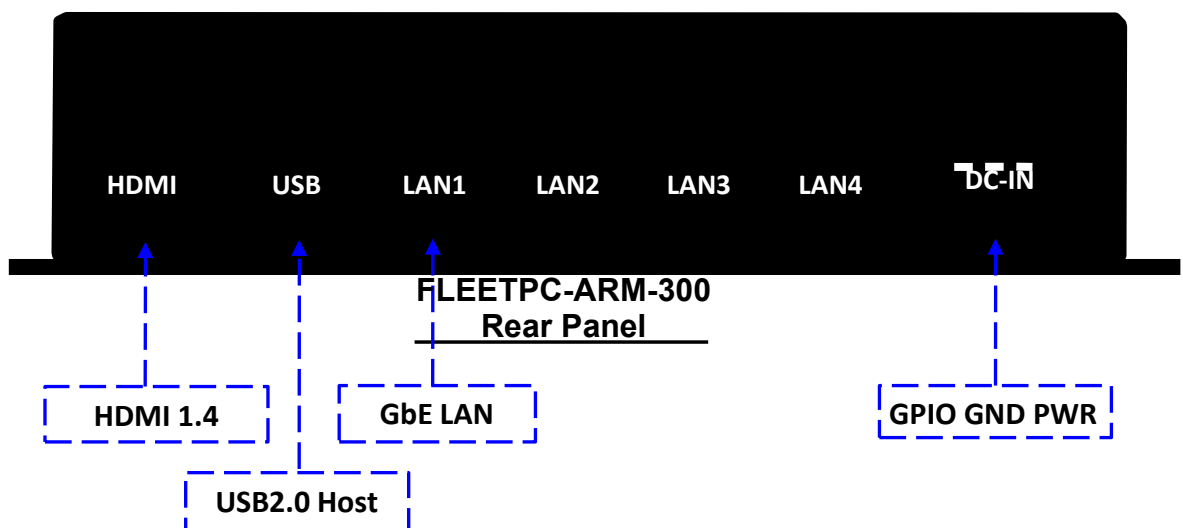
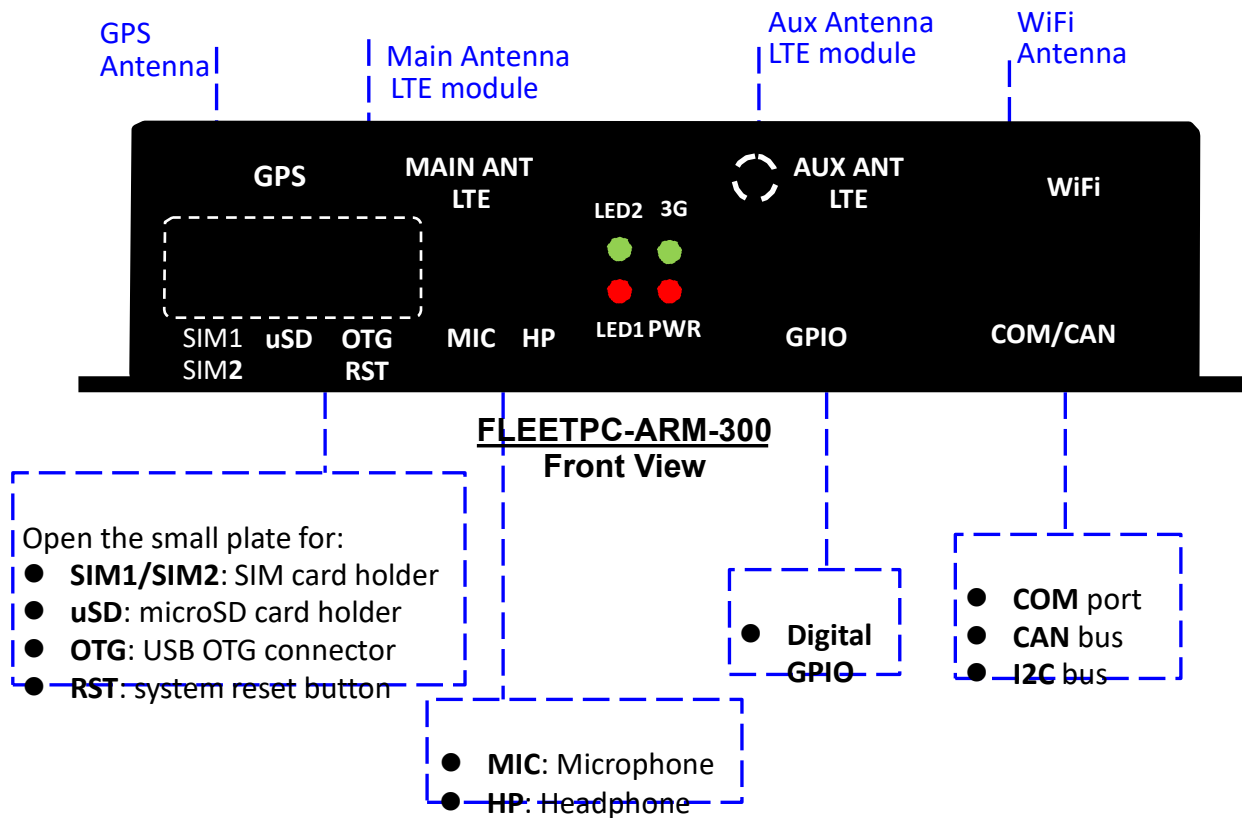

For detailed descriptions of the FLEETPC-ARM-300 connector functions, please refer to **FLEETPC-ARM-100 Reference Manual**.

3 FLEETPC-ARM-300 Installation

FLEETPC-ARM-300 installation is divided into two portions, basic installation and full

installation. You are allowed to perform the following functions after completing basic

installation:

(1). A PC (or a mobile phone, a tablet with WiFi function) is connected to internet through FLEETPC-ARM-300, and

(2). A PC (or a mobile phone, a tablet with WiFi function) may communicate FLEETPC-ARM-300 device manager using browser for enquiring various VPC I/O settings, GPS coordinates, etc. For more information about detailed functions of FLEETPC-ARM-300 device manager, please refer to Appendix A in this manual.

You are allowed to perform the following functions after completing full installation:

(1). All functions completed under the basic installation

(2). FLEETPC-ARM-100 can send information (GPS, I/O, etc.) to remote Server OpenGTS

For more information about the installations, please refer to “Section 3.1 Basic Installation” and “Section 3.2 Full Installation”.

3.1 Basic Installation

You need to prepare the following devices and accessories before basic installation:

- One FLEETPC-ARM-300
- One 3G or LTE SIM Card
 - Note that 3G or LTE module has to be purchased separately.
- One network cable and one PC (Windows), or
- One mobile phone/tablet/PC/NB device with WiFi function

Step 1 : Inserting sim card into sim card holder SIM1 on FLEETPC-ARM-300 (as shown below):

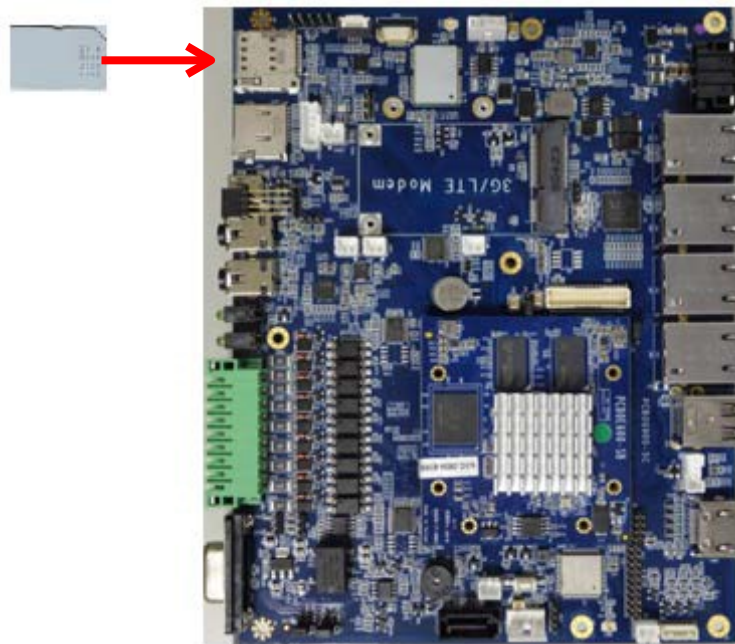

Step 2 : Connecting 3G/LTE, Wi-Fi, GPS antennas onto antenna connectors on FLEETPC-ARM-300 (shown as dashed circles in the figure below). Note: WiFi, 3G/LTE and GPS antennas have to be purchased separately.

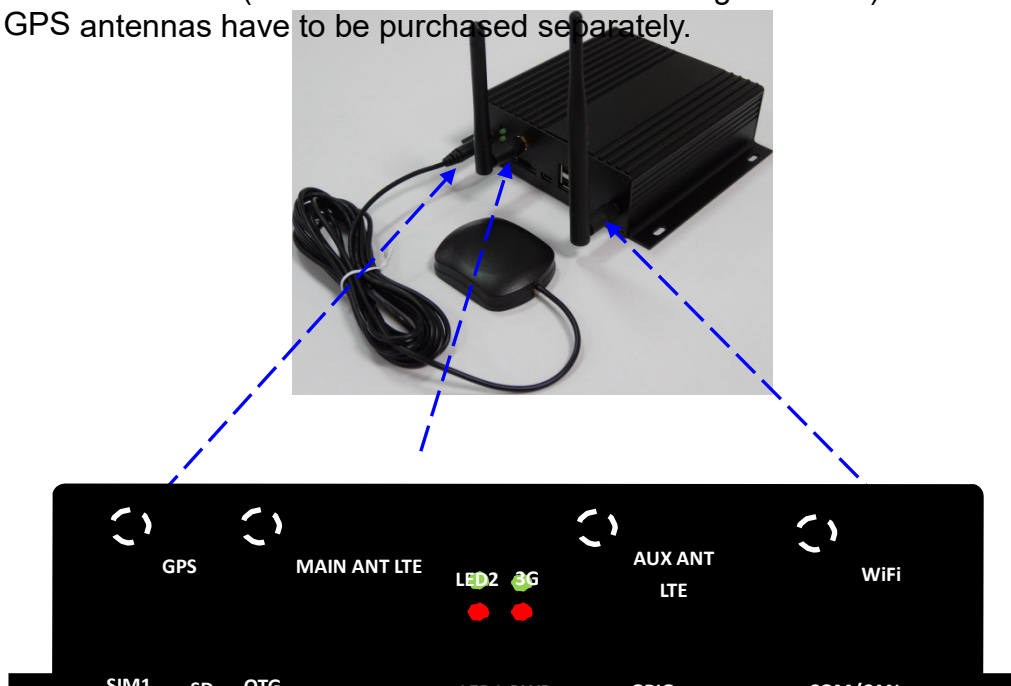

If you want to:

- Connect FLEETPC-ARM-300 to PC with a network cable, go to **Step 3**.
- Connect FLEETPC-ARM-300 to a mobile phone or tablet with WiFi function, go to **Step 4**.

Step 3 : Connecting one end of a network cable to FLEETPC-ARM-300 LAN port and connecting the other end to PC LAN port. Connect power line to PWR connector on FLEETPC-ARM-300. Note: PC is a DHCP client, and fixed IP setting is not allowed. In PC browser, type

<http://192.168.1.1> to connect to FLEETPC-ARM-300 device manager.

Network settings on FLEETPC-ARM-300:

- Default LAN IP address is 192.168.1.1
- Username: admin & Password: 12345678.
- FLEETPC-ARM-300 is a DHCP server and it will broadcast an IP address to PC (192.168.1.2 ~ 192.168.1.100).

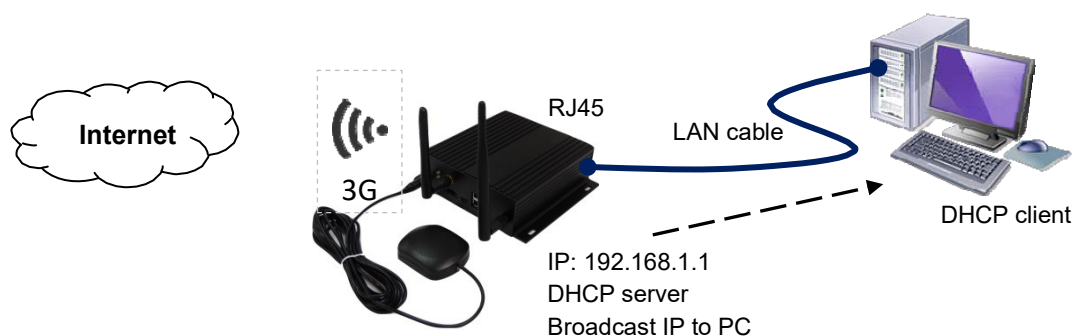

Step 4 : Setting the following wireless network settings on an available mobile phone or a tablet with WiFi function:

- WiFi AP SSID name for FLEETPC-ARM-300: F600-AP
- WiFi frequency : Channel 4
- WPA mode

To activate FLEETPC-ARM-300 device manager, enter <http://192.168.2.1> on mobile or tablet browser.

- Default WiFi IP address is 192.168.2.1
- Username: admin & Password: 12345678.
- FLEETPC-ARM-300 is a DHCP server and it will broadcast an IP address to WiFi phone or tablet (192.168.2.2 ~ 192.168.2.100).

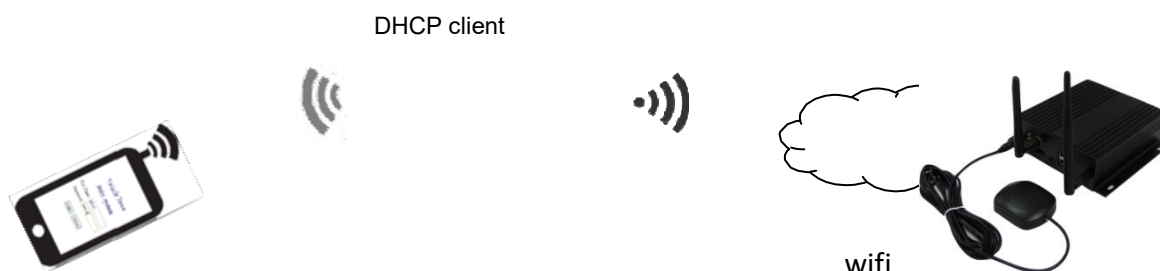

FLEETPC-ARM-300 Quick Start Guide

IP:

192.168.2.1

DHCP

server

Broadcast IP
to phone

Internet

Note:

FLEETPC-ARM-300 Ethernet default IP: 192.168.1.1

FLEETPC-ARM-300 Ethernet DHCP server IP range: 192.168.1.2 ~ 192.168.1.100

FLEETPC-ARM-300 WiFi default IP: 192.168.2.1

FLEETPC-ARM-300 WiFi DHCP server IP range: 192.168.2.2 ~ 192.168.2.100

While connecting to FLEETPC-ARM-100 device manager, you can either type <http://192.168.1.1> or <http://192.168.2.1>. FLEETPC-ARM-100 has two IP addresses (for Ethernet and WiFi, 2 network devices). Two network segments 192.168.1.x and 192.168.2.x are bridged together in FLEETPC-ARM-100.

Step 5 : If you complete above Step1~Step4 you have completed basic installation on FLEETPC-ARM-300. After entering FLEETPC-ARM-300 device manager on PC (or a phone or a tablet with

WiFi function), you may connect to Internet through 3G/LTE modem.

For more information about detailed FLEETPC-ARM-300 device manager functions, refer to

Appendix A.

3.2 Full Installation

You need to prepare the following devices and accessories before full installation:

- One FLEETPC-ARM-300
- One 3G or LTE SIM Card
 - Note: 3G or LTE module has to be purchased separately
- One network cable and one PC (Windows), or
- One mobile phone/tablet/PC/NB device with WiFi function
- One PC (Windows), which can be installed OpenGTS server software

Before starting full installation, make sure you have successfully completed the basic installation steps described in previous section.

If it is not properly installed, please complete basic installation first.

➤ **OpenGTS server Installation**

Please refer to Appendix B or Appendix C for detailed OpenGTS server installation.

3.3 Remote Access

FLEETPC-ARM-300 is pre-installed a VNC server allowing remote PC (Ubuntu or Windows) to connect to FLEETPC-ARM-300 via LAN port or WiFi. This feature enables remote PCs to monitor and control FLEETPC-ARM-300 without a local LCD display.

Please refer to Appendix D for information about how to use Remote Access.

Appendix A: FLEETPC-ARM-300 Device Manager

The default IP address for FLEETPC-ARM-300 is 192.168.1.1

In your browser's address bar, enter <http://192.168.1.1>.

Enter username & password (default username: admin, password: 12345678), and press Login to log into the system.

NOTE: The source code of FLEETPC-ARM-300 Device Manager is available for your modification after a purchase. For more information, please contact our sales representative.

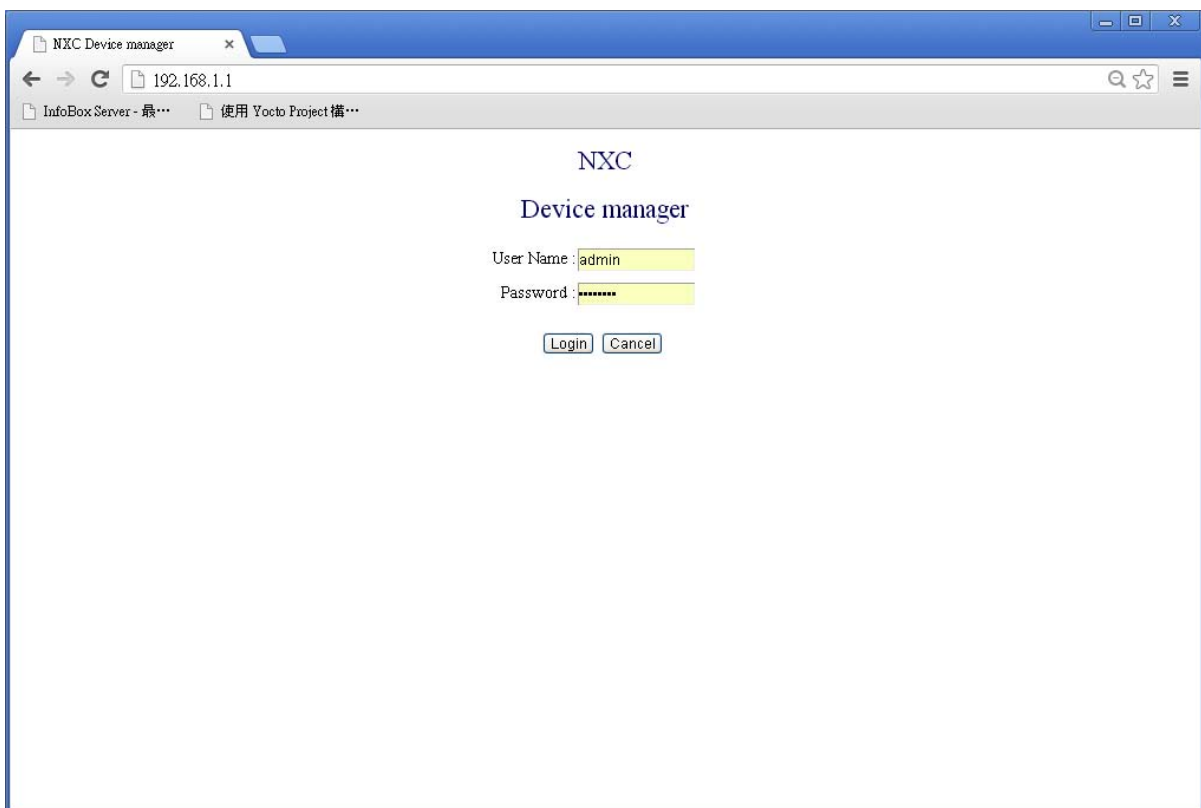

A-1 GPS function

When GPS antenna is connected and with signal quality, FLEETPC-ARM-300 device manager will display GPS coordinates at 1Hz frequency (refresh coordinates 1 time per second).

Note: The map used in device manager is Google Map. The PC (or mobile phone) must be connected to Internet for browser to show GPS coordinates with Google Map.

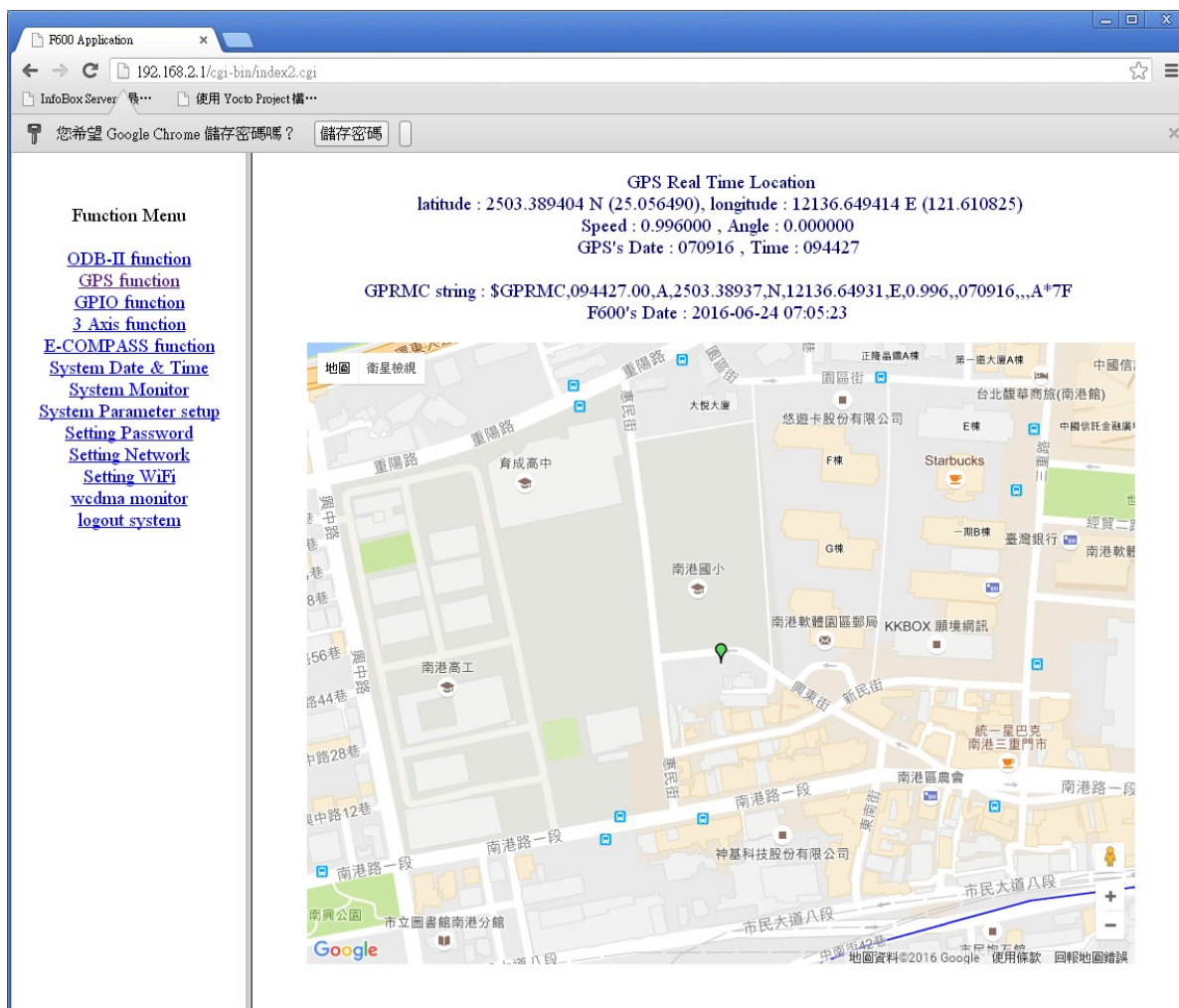

A-2 GPIO function

GPIO OUT can set HIGH/LOW value and output it to GPO pin on FLEETPC-ARM-300. For example, to enable (turn on) LED 1, select HIGH on device manager and press <Change it> to modify its setting. To disable (turn off) LED 1, select LOW on device manager and press <Change it> to modify its setting.

GPIO IN on device manager can display FLEETPC-ARM-300 GPIO input values.

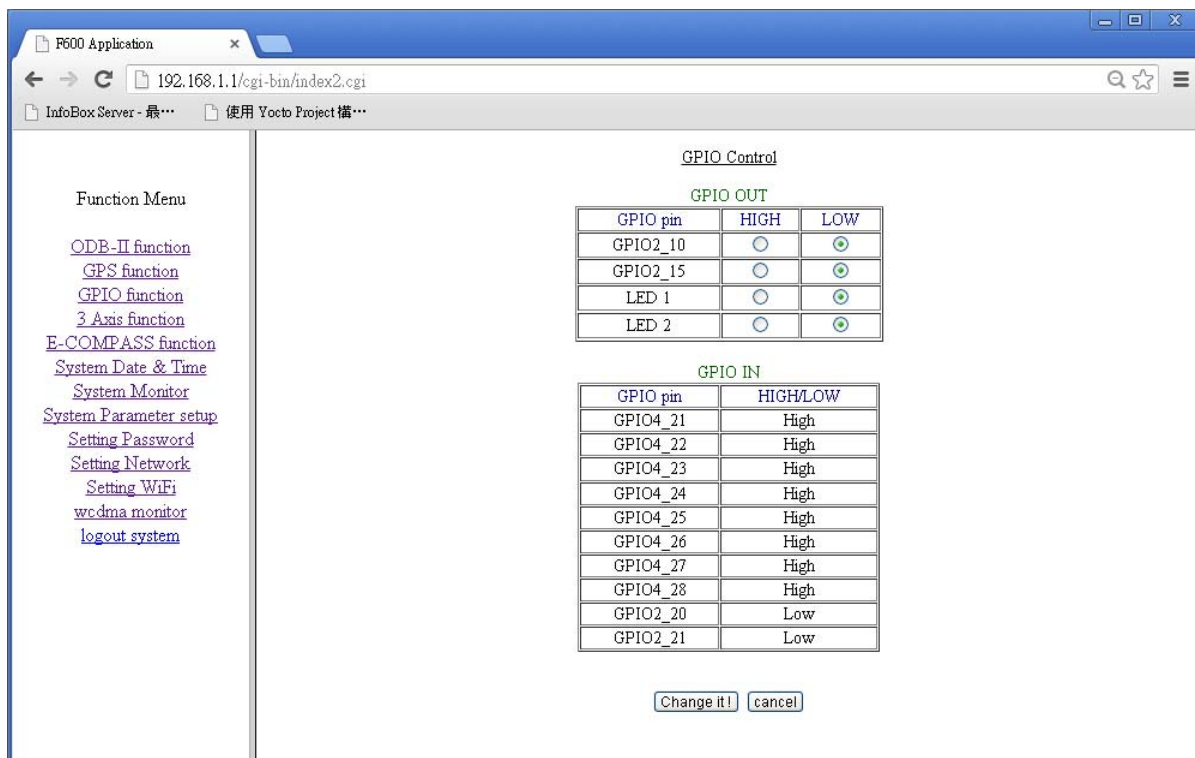

A-3 3-Axis G-sensor Data

This function of 3-axis micro accelerator can measure the changes of x, y, z axes based on the gravity.

In case the GPS signal quality is poor and this signal loses GPS navigation ability, the 3-axis information combined with E-compass can be used to establish a complementary azimuth computing system.

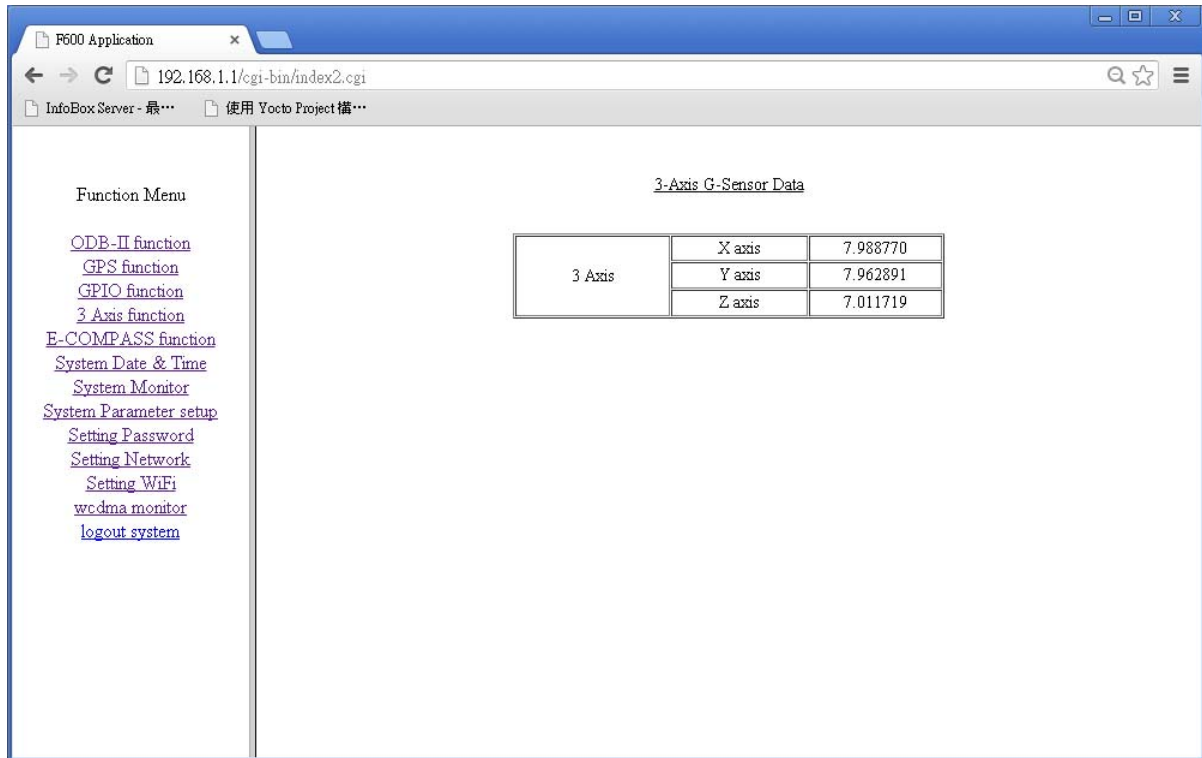

A-4 E-compass function

This page displays FLEETPC-ARM-300 on-board E-compass 3-axis (x, y, z) data. E-compass reports the data by measuring the direction of the Earth's magnetic field. This function can be used to show your present vehicle direction.

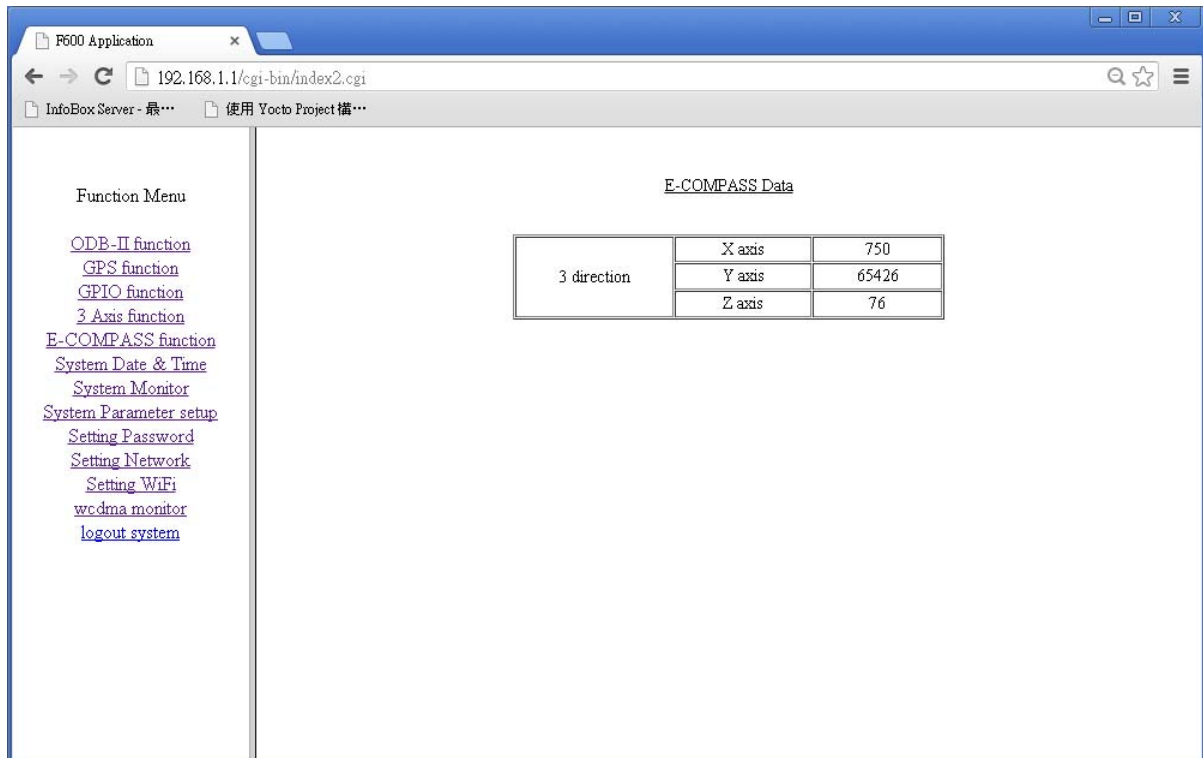

3 direction	X axis	750
3 direction	Y axis	65426
3 direction	Z axis	76

A-5 System Date & Time

This function allows user to set system date and time. In lower portion of user interface, you may use New Date & Time to set system date and time, and click <Change it> to change the present time to new system date and time.

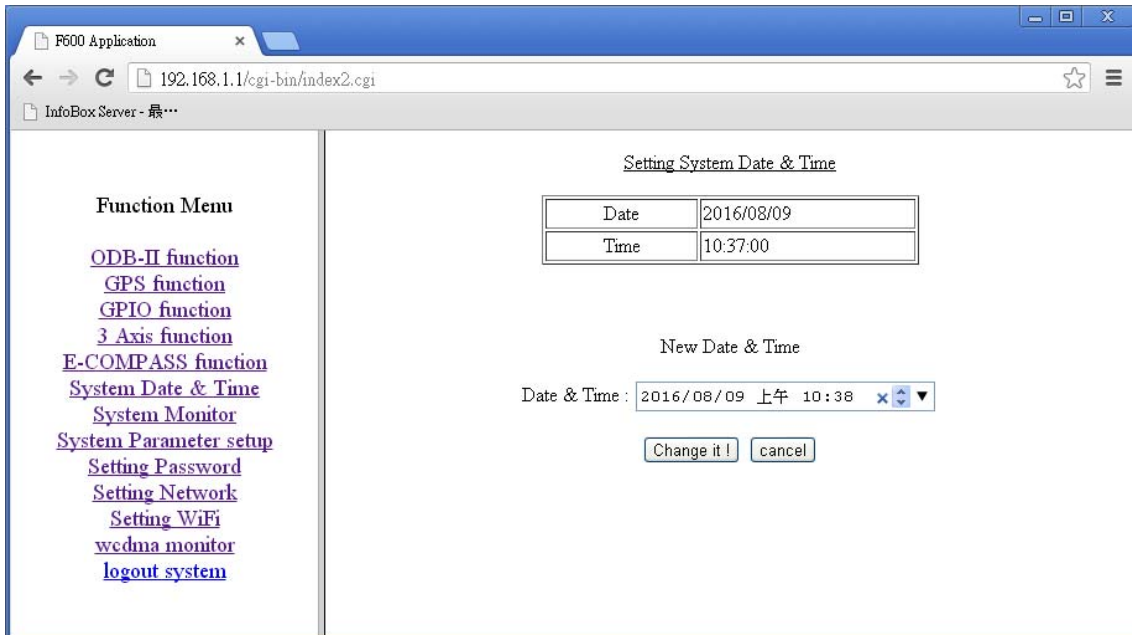

A-6 System Monitor

This System Monitor function can display current usage of CPU & memory on FLEETPC-ARM-300.

- CPU frequency: For showing present processor operating frequency
- CPU usage: For showing present processor usage (loading)
- Memory Size
 - Total: For showing total system memory capacity
 - Free: For showing free system memory capacity
- CPU Temperature: For showing present processor temperature

If you need to reboot system, please click <Reboot System > (when you set/update new system parameters or password, use this button to reboot system).

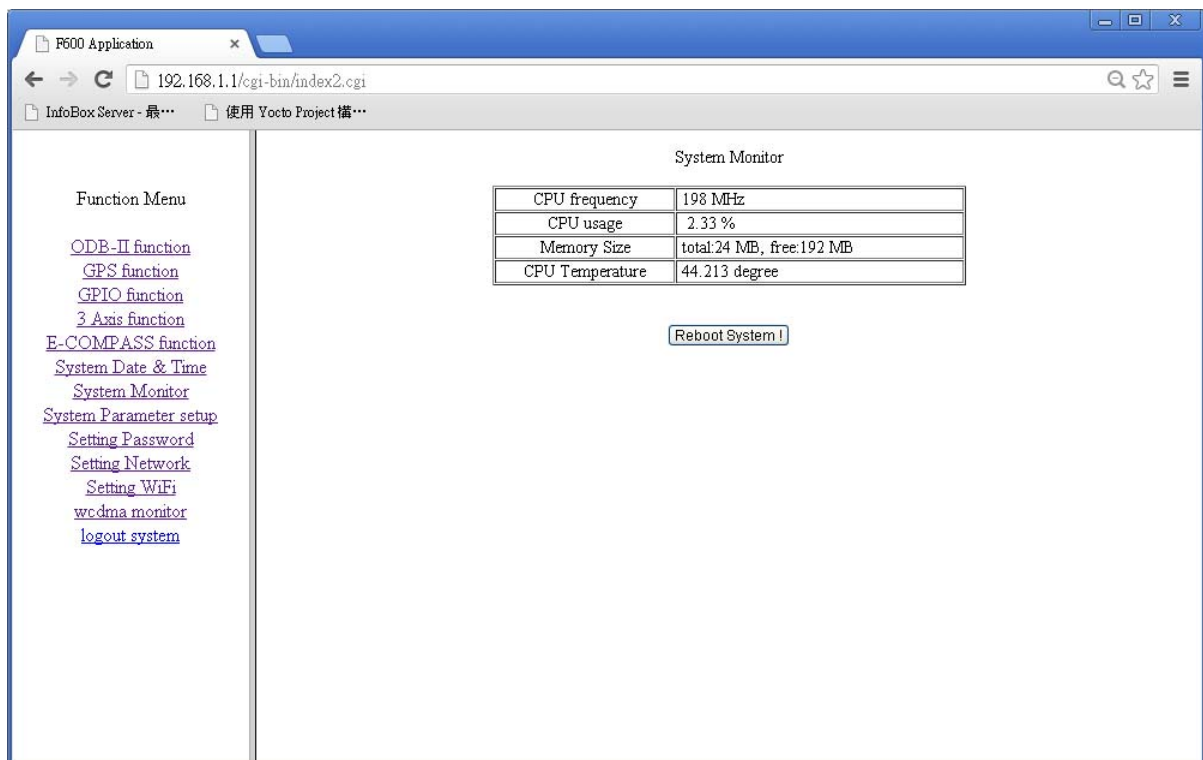

A-7 System Parameter setup

This function allows you to set some system parameters:

- OpenGTS Sever IP: for setting OpenGTS Server TCP/IP information
- Unique ID: It sets present device ID. User can setup device ID for this device. Do not use the same ID on multiple devces (ID must be UNIQUE).
- Connect Periodic: for showing connection time (in minutes), which is an unchangeable value.
- Connect Interval: for setting the connection interval of auto-retry (in minutes).
- Event Interval: It sets the time interval to send event signal to the device (in minutes) , in case the connection is failed.
- WCDMA produce path: for showing a directory storing batch command for 3G/LTE connection, and this directory is unchangeable.
- Bluetooth MAC address: for setting Bluetooth MAC address.
- UTC Location: for setting the current time zone of the device location.
- Enable GTS UTC Time: for using GPS standard time and updating system time after it is checked.
- 3G/LTE Dial-up Parameter Setting: for setting 3G/LTE dial-up parameters (Note: For more information about APN parameters, please consult your local telecommunication service provide or visit Internet at <http://www.imei.info/faq-apn/> .

After completing all settings, click <Change it> to update system parameter settings.

Note: You MUST reboot your system to activate all parameters.

The screenshot shows a web browser window titled "F600 Application" with the URL "192.168.1.1/cgi-bin/index2.cgi". The browser's address bar and tabs are visible at the top. The main content area is divided into two sections:

Function Menu

- [ODB-II function](#)
- [GPS function](#)
- [GPIO function](#)
- [3 Axis function](#)
- [E-COMPASS function](#)
- [System Date & Time](#)
- [System Monitor](#)
- [System Parameter setup](#)
- [Setting Password](#)
- [Setting Network](#)
- [Setting WiFi](#)
- [wcdma monitor](#)
- [logout system](#)

System Parameter Setting

OpenGTS Sever IP	203.67.100.143
Unique ID	gprmc_123456789012345
Connect Periodic (minutes)	120
Connect Interval (minutes)	60
Event Interval (seconds)	10
wcdma produce path	/home/root/wcdma.sh
ODB-II Bluetooth mac address	EC:11:27:68:E0:E0
UTC Location	GMT+08:00
Enable GPS UTC Time	<input checked="" type="checkbox"/>

3G Dial Parameter Setting

Dialup number example : ATDT*99# or ATD*99***1# or ...

APN parameter example : AT+CGDCONT=1,"IP","INTERNET",,0,0

Dialup number	ATDT*99#
3G APN parameter 1	IP
3G APN parameter 2	INTERNET

Change it! cancel

A-8 Setting Password

Enter your new system login password in New Password field, and click <Change it> to update your old password to the new one.

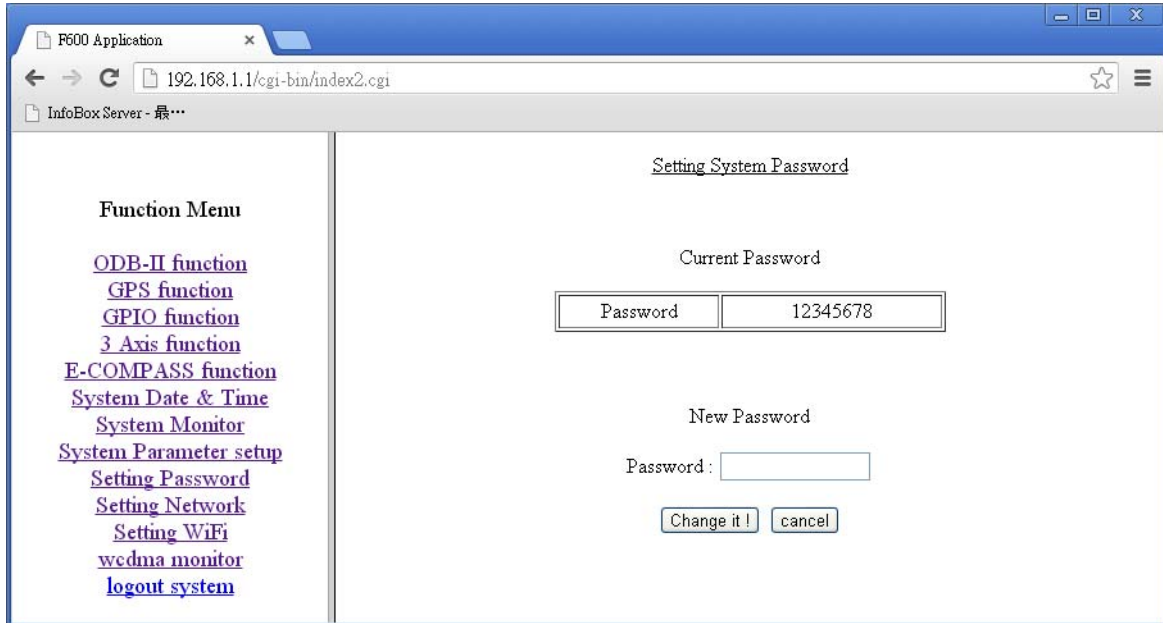

A-9 Setting Network

Wlan0(WiFi interface) IP setting: for showing and/or setting present TCP/IP, DNS, DHCP for WiFi network.

Eth0(Ethernet interface) IP setting: for showing and/or setting present TCP/IP, DNS, DHCP for Ethernet.

After completing all network settings, click <Change it> to save them.

The screenshot shows a web browser window titled 'F600 Application' with the address bar displaying '192.168.1.1/cgi-bin/index2.cgi'. The page content is divided into a left sidebar and a main content area.

Function Menu (Left Sidebar):

- [ODB-II function](#)
- [GPS function](#)
- [GPIO function](#)
- [3 Axis function](#)
- [E-COMPASS function](#)
- [System Date & Time](#)
- [System Monitor](#)
- [System Parameter setup](#)
- [Setting Password](#)
- [Setting Network](#)
- [Setting WiFi](#)
- [wcdma monitor](#)
- [logout system](#)

wlan0 (WIFI interface) IP setting (Main Content):

TCP/IP	IP address	192.168.2.1
	netmask	255.255.255.0
DNS	DNS 1	8.8.4.4
	DNS 2	8.8.8.8
DHCP ranges	Start IP	192.168.2.2
	End IP	192.168.2.100

eth0 (Ethernet interface) IP setting (Main Content):

TCP/IP	IP address	192.168.1.1
	netmask	255.255.255.0
DNS	DNS 1	8.8.4.4
	DNS 2	8.8.8.8
DHCP ranges	Start IP	192.168.1.2
	End IP	192.168.1.100

At the bottom of the main content area, there are two buttons: **Change it !** and **cancel**.

A-10 Setting WiFi

WiFi Access Point Parameters Setting:

- SSID: for setting WiFi Access Point name.
- Channel: for setting WiFi channel.
- Operation Mode: WiFi standard/protocol (b/g/n).
- Security Mode: for setting WiFi encryption protocol.
- WiFi Password: for setting WiFi password.

After completing all settings, click <Change it> to update system settings.

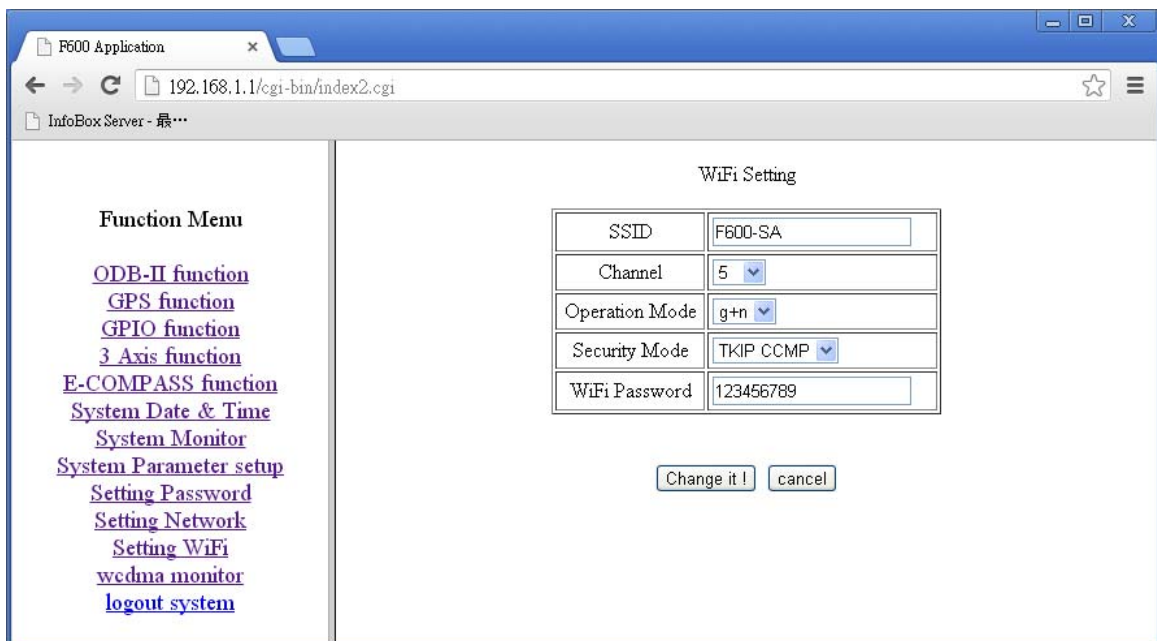

A-11 wcdma monitor

This function is to show the status of 3G/LTE modem.

- SIM card: for showing a message about whether SIM card is detected.
- Mode: for showing SIM card transmission mode for wireless transmission (GSM(2G), WCDMA(3G), LTE)
- sub-mode: for showing SIM card transmission mode for wireless transmission (GSM/GPRS/EDGE/HSDPA/HSUPA/HSPA/HSPA+)
- signal strength: for showing 3G/LTE connection signal strength.

The screenshot shows a web browser window titled 'F600 Application' with the address bar displaying '192.168.1.1/cgi-bin/index2.cgi'. The page content is divided into two main sections. On the left is a 'Function Menu' with several links: ODB-II function, GPS function, GPIO function, 2 Axis function, E-COMPASS function, System Date & Time, System Monitor, System Parameter setup, Setting Password, Setting Network, Setting WiFi, wcdma monitor, and logout system. The 'wcdma monitor' link is highlighted. On the right, under the heading 'WCDMA module status', there is a table with the following data:

SIM card	found
mode	"WCDMA"
sub-mode	"WCDMA"
signal strength (-120 ~ -25 dBm)	-66 dBm

Appendix B: OpenGTS Installation (Windows)

OpenGTS is a web server based system created with Java (Open source) so you are required to install a web server (Tomcat). For recording vehicle traveling status, you need to additionally install a MySQL database. Because the web server will connect to MySQL, you need to install MySQL JDBC Driver. OpenGTS has a function to inform user by mail in case of the occurrence of any event so you also need to install Java mail API.

Note: OpenGTS software and its trademark are not part of FLEETPC-ARM-100 products.

For more information, visit web site at <http://www.opengts.org/>.

B-1 Hardware Requirements

- 1.) Windows 20XX, Windows vista, Windows 7 or windows 10
- 2.) CPU: Intel i3 or later
- 3.) RAM size: 4G bytes
- 4.) HDD: at least 5G bytes free space

B-2 Software Requirements

- 1.) Oracle JDK 8 (Java Compiler for OpenGTS source code)
- 2.) Sun Java Mail API (mail event to user by OpenGTS system)
- 3.) Apache Ant tool (Java Build tool for Java Compiler)
- 4.) Apache Tomcat (Web Server for OpenGTS System)
- 5.) MySQL (Database Server for OpneGTS)
- 6.) MySQL JDBC (Database driver for Java & Tomcat)
- 7.) OpenGTS

B-3 Steps to Install OpenGTS

1.) Installing Oracle JDK 8

Download : JDK 8 (jdk-8u91-windows-i586.exe)

Download Link : <http://www.java.com/en/download/manual.jsp>

You simply launch jdk-8u91-windows-i586.exe, and it will start to install JDK & JRE. Before installing, you NEED to create two file folders -- C:\Program File(x86)\Java\jdk1.8.0_91\ and C:\Program File(x86)\Java\jre1.8.0_91\, because Ant Tool Build does not allow you to leave them blank while installing.

Setup folders and system parameters:

In Windows desktop, click **Start** → **Programs** → **Accessories** and right click on "**Command Line Tool**", and select "**Run as Administrator**" to run Windows command line tool. In command line tool, enter below commands:

- md C:\ProgramData\Oracle\Java\javapath\
- cd c:\ProgramData\Oracle\Java\javapath\
- mklink /D JDK "C:\Program File(x86)\Java\jdk1.8.0_91\"

In Windows desktop, click **Start** → **Setup** → **Console** and click **System** → **Advanced** → **Environment Variable**. In Environment Variable, add a system variable JAVA_HOME.

Setting this system environment variable as below:

JAVA_HOME → C:\ProgramData\Oracle\Java\javapath\

2.) Installing Sun JavaMail API

Download : javax.mail.jar

Download Link : <http://www.oracle.com/technetwork/java/index-138643.html>

In Windows desktop, click **Start** → **Programs** → **Accessories** and right click on "**Command Line Tool**", and select "**Run as Administrator**" to run Windows command line tool. Copy javax.mail.jar to the following two file folders:

- copy c:\your download path\ javax.mail.jar C:\Program File(x86)\Java\jdk1.8.0_91\jre\lib\ext\
- copy c:\your download path\ javax.mail.jar C:\Program File(x86)\Java\jre1.8.0_91\lib\ext\

3.) Installing Apache Ant Build Tool

Download : apache-ant-1.9.4-bin.zip

Download Link : <https://ant.apache.org/bindownload.cgi>

After downloading this archive file, decompress it and all files will be extracted to this folder D:\ apache-ant-1.9.4 (disk D:\ preferred), and also assign D:\ apache-ant-1.9.4\bin to your system variable PATH.

(To change PATH variable, in Windows desktop click **Start** → **Setup** → **Console**, and then click **System** → **Advanced** → **Environment Variables** to edit system variable PATH)

4.) Installing Tomcat v7.x (DO NOT install V8 version)

Download : apache-tomcat-7.0.69.exe

Download Link : <https://tomcat.apache.org/download-70.cgi>

After downloading, run apache-tomcat-7.0.69.exe with default configuration option. Disk D:\ is preferred for target installation. After completing installation, you also need to add system variable.

In Windows desktop, click **Start** → **Setup** → **Console** and then click **System** → **Advanced** → **Environment Variables**.

In system environment variables, add a system variable CATALINA_HOME. Set the system environment variable CATALINA_HOME to D:\Tomcat 7.0

5.) Installing MySQL v5.X.X

Download : mysql-essential-5.1.45-winx64.msi

Download Link : <http://dev.mysql.com/downloads/mysql/> or <http://www.eisafe.com/safe/x64/>

After downloading, simply run mysql-essential-5.1.45-winx64.msi. During installation, be sure to click checkbox to set PATH for MySQL bin (for MySQL executable files).

6.) Installing MySQL JDBC Driver

Download : mysql-connector-java-5.1.38.zip

Download Link : <https://dev.mysql.com/downloads/connector/j/>

After downloading & unzipping, in Windows desktop click **Start** → **Programs** → **Accessories** and right click on “**Command Line Tool**” and select "Run as Administrator" to enter command line tool. Copy mysql-connector-java-5.1.38-bin.jar to the following two folders:

- ① C:\Program File(x86)\Java\jdk1.8.0_91\jre\lib\ext\
- ② C:\Program File(x86)\Java\jre1.8.0_91\lib\ext\

7.) Installing and Compiling OpenGTS

Download : OpenGTS_2.6.1.zip

Download Link : <http://www.opengts.org/>

After downloading, unzip the file and extract them to folder D:\OpenGTS_2.6.1 (disk D:\ preferred).

In Windows desktop, click **Start** → **Setup** → **Console** and click **System** → **Advanced** → **Environment Variables**.

In system environment variables, add a system variable GTS_HOME.

Set this system environment variable GTS_HOME to D:\OpenFTS_2.6.1

Before compiling, verify all environment variables again to make sure they are all correct (including path setting):

- ① JAVA_HOME
- ② ANT_HOME

- ③ CATALINA_HOME
- ④ GTS_HOME

To starting your compilation, click windows **Start** → **Programs** → **Accessories** in Windows desktop and click on “**Command Prompt**” and select "Run as Administrator" to open a command prompt, and type the following commands:

```
C:\> D:
D:\> cd OpenGTS_2.6.1
D:\ OpenGTS_2.6.1> ant all
```

The following files will be created under the “build” folder if commands are properly executed:

- ① "lib/gtsutils.jar" – This jar contains the base utilities and db access tools.
- ② "lib/gtsdb.jar" – This jar contains the database access utilities and table definition.
- ③ "lib/gtsdmtp.jar" – This jar contains the SQL db data store wrappers around the OpenDMTP server.
- ④ "lib/tools.jar" – This jar contains miscellaneous system check and administrative tools.
- ⑤ "track.war" – This "war" file (web-archive) contains the web-interface 'Track' servlet.
- ⑥ "events.war" – This "war" file contains the web accessible eventData access servlet.
- ⑦ "mologogo.war" – This "war" file contains the Mologogo device servlet.
- ⑧ "gc101.war" – This "war" file contains support for the Sanav GC-101 device.
- ⑨ "gprmc.war" – This "war" file contains a servlet support server for a generic http-based device server.

8.) Initializing OpenGTS in MySQL Database

Creating a database on OpenGTS, and its name is gts.

In the folder D:\OpenGts_2.6.1, execute the following command:

```
bin\initdb.bat "-rootUser:root" "-rootPass:userPass"
```

(userPass: use your own password, for example. bin\initdb.bat "-rootUser:root" "-rootPass:icn" , password is icn)

MySQL Server should be running now. If not, you should manually launch it

and thus a database gts and the following data tables will be created:

- ① **Account** - Account owner table
- ② **User** - User table
- ③ **UserAcl** - User Access-Control-List table
- ④ **Device** - Device information table
- ⑤ **EventData** - Received Event data
- ⑥ **Geozone**- Geozone/Geofence definitions
- ⑦ **EventTemplate** - Custom event packet templates (DMTP only)
- ⑧ **PendingPacket** - Packets pending transmission to device (DMTP only)

Checking Your Installation Status:

In the folder D:\OpenGts_2.6.1, execute the following command:

```
bin\checkInstall.bat
```

Creating Administrator Account on OpenGTS:

In the folder D:\OpenGts_2.6.1, execute the following command to create administrator account:

```
bin\admin.bat Account -account:sysadmin -pass:password -create  
(Set the administrator password at -pass , e.g. bin\admin.bat Account  
-account:sysadmin -pass:test -create , password is test)
```

9.) Installing *.war to Tomcat sever

In D:\OpenGts_2.6.1\build folder, execute the following commands:

```
copy *.war D:\Tomcat 7.0\webapps  
(*war including track.war, events.war, gprmc.war)
```

If any event occurs and you must send out a notification mail, you should find SMTP settings in the file D:\OpenGTS_2.6.1\config.conf and then change it to your SMTP server IP and launch ant all (compile.opengts) to copy *.war to the folder D:\Tomcat 7.0\webapps.

10.) Testing OpenGTS server

To test OpenGTS on the local server (the PC installed with OpenGTS), type either one of the following two URL address in browser:

<http://localhost:8080/track/Track> or <http://127.0.0.1:8080/track/Track>

You will see the OpenGTS login screen. In Account field, enter your account,

and in Password field, enter your password

(Account and Password are created by executing the command

bin\admin.bat Account -account:sysadmin -pass:password -create).

Appendix C: OpenGTS Installation (Linux)

Note: OpenGTS is used as a demonstration server to work with FLEETPC-ARM-100. It is not part of FLEETPC-ARM-100 product. Please check below link for more information on OpenGTS: <http://www.opengts.org/>

C-1 Host Computer

Setup a Linux host computer with the following minimum software and hardware requirements:

- Ubuntu version 12.04 or later
- 120GB hard drive free space (for X11 backend)

C-2 OpenGTS Installation procedures

- Install ubuntu 10.04 server + LAMP + Java Tomcat

```
sudo aptitude update
sudo aptitude safe-upgrade
```
- Remove apparmor

```
sudo /etc/init.d/apparmor stop
sudo update-rc.d -f apparmor remove
sudo aptitude remove apparmor apparmor-utils
```
- Install package

```
sudo aptitude install binutils cpp fetchmail flex gcc libarchive-zip-perl libc6-dev
libcompress-zlib-perllibdb4.6-dev libpcre3 libpopt-dev lynx m4 make ncftp
nmap openssl perl perl-modules unzip zip zlib1g-dev autoconf automake1.9
libtool bison autotools-dev g++ build-essential
```
- Edit /etc/mysql/my.cnf

```
bind-address = 127.0.0.1 → #bind-address = 127.0.0.1
```
- Edit /etc/apache2/mods-available/dir.conf

```
DirectoryIndex index.html index.htm index.shtml index.cgi index.php
index.php3 index.pl index.xhtml
```

```
sudo a2enmod ssl
sudo a2enmod rewrite
sudo a2enmod suexec
sudo a2enmod include
sudo a2enmod dav_fs
sudo a2enmod dav
sudo /etc/init.d/apache2 restart
```

- Disable ruby

```
sudo vi /etc/mime.types
#application/x-ruby
/etc/init.d/apache2 restart
```

- Install Perl modules

```
sudo aptitude install libhtml-parser-perl libdb-file-lock-perl libnet-dns-perl
libnetaddr-ip-perl libarchive-tar-perl
```

- Add & Install repository and Java

```
sudo apt-get install python-software-properties
sudo add-apt-repository "deb http://archive.canonical.com/ lucid partner"
sudo apt-get update
```

- Install java open-jdk-6

```
sudo apt-get install default-jdk
```

- Setup Tomcat

```
vi /etc/tomcat6/tomcat-users.xml
add following line :
<role rolename="manager"/>
<role rolename="admin"/>
<user username="admin" password="admin" roles="admin,manager"/>
```

- Install ANT

```
sudo apt-get install ant
```

- Setup environment

```
add following line to /etc/environment :
export JAVA_HOME=/usr/lib/jvm/java-6-openjdk
export ANT_HOME=/usr/share/ant
export CATALINA_HOME=/usr/share/tomcat6
```

```
export GTS_HOME=/usr/local/OpenGTS
```

- Setup mysql JDBC

```
wget -c
```

```
http://dev.mysql.com/get/Downloads/Connector-J/mysql-connector-java-5.1.18.tar.gz
```

```
tar xzvf mysql-connector-java-5.1.18.tar.gz
```

```
sudo cp mysql-connector-java-5.1.18-bin.jar $JAVA_HOME/jre/lib/ext/
```

```
sudo ln -s /usr/local/OpenGTS_2.6.0 /usr/local/OpenGTS
```

- Download OpenGTS :

Download OpenGTS from <http://www.opengts.org/>

```
unzip OpenGTS_2.6.0.zip
```

```
sudo cp OpenGTS_2.6.0 /usr/local
```

- Then we **ant** all files and deploy **track.war** file.

```
ant all
```

```
ant track.war
```

use tomcat manager to deploy:

(assuming your PC IP address is 192.168.200.150)

```
http://192.168.200.150:8080/manager/html
```

```
deploy path /var/lib/tomcat6/webapps
```

- Initialize OpenGTS database

```
cd /usr/local/OpenGTS_2.6.0/bin
```

```
./initdb.sh -rootUser=root -rootPass=root
```

(Note: -rootPass is root password, you can change it if you want)

- Create Admin account

```
./admin.sh Account -account=admin --create
```

```
./admin.sh Account -account=admin --edit
```

```
./admin.sh Account --list
```

- Setup link

```
cd /usr/local
```

```
sudo ln -s $JAVA_HOME java
```

```
sudo ln -s $CATALINA_HOME tomcat
```

```
sudo ln -s $GTS_HOME gts
```

- Run Device server

```
bin/runserver.sh -s gtsdmtmp
```

- Show java process
\$GTS_HOME/bin/psjava
- Installing “events.war”
ant events
use tomcat manager to deploy
(assuming your PC IP address is 192.168.200.150)
<http://192.168.200.150:8080/manager/html>
- HTTP Based Device Communication Servers (using the "gprmc" servlet)
Building the "gprmc" Servlet:
ant gprmc
use tomcat manager to deploy
(assuming your PC IP address is 192.168.200.150)
<http://192.168.200.150:8080/manager/html>
- List running task
\$GTS_HOME/bin/psjava

C-3 Change OpenGTS map provider to Google Map

edit build/track/WEB-INF/private.xml

Apply **google map API key** from Google.

Find <MapProvider name="**openLayers**"> tag

```
active="${Domain.MapProvider.active=false}"
```

```
??/span>
```

...

```
<MapProvider name="googleMaps" active="${Domain.MapProvider.active=true}"
```

```
class="org.opengts.war.maps.jsmap.GoogleMaps"
```

```
key="${Domain.MapProvider.key=AlzaSyBc1Y4npcHdkkQYT1NopchLcu-N  
RMgcrfl}"
```

```
rtPropPrefix="Domain.MapProvider.">
```

Then rebuild track and deploy again.

Appendix D: FLEETPC-ARM-300 Remote Access

To use FLEETPC-ARM-300 remote access function, you need a Ubuntu PC or Windows PC connected to FLEETPC-ARM-300 via LAN cable or WiFi. The FLEETPC-ARM-300 default IP address is 192.168.1.1 or 192.168.2.1.

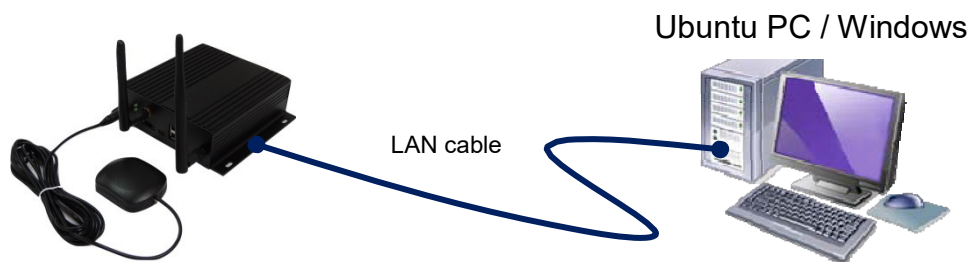

D-1 Access FLEETPC-ARM-300 from a remote Ubuntu PC

- 1.) Install xvnc4viewer software on Ubuntu PC (or in Terminal screen, type this command: `# sudo apt-get install xvnc4viewer`)

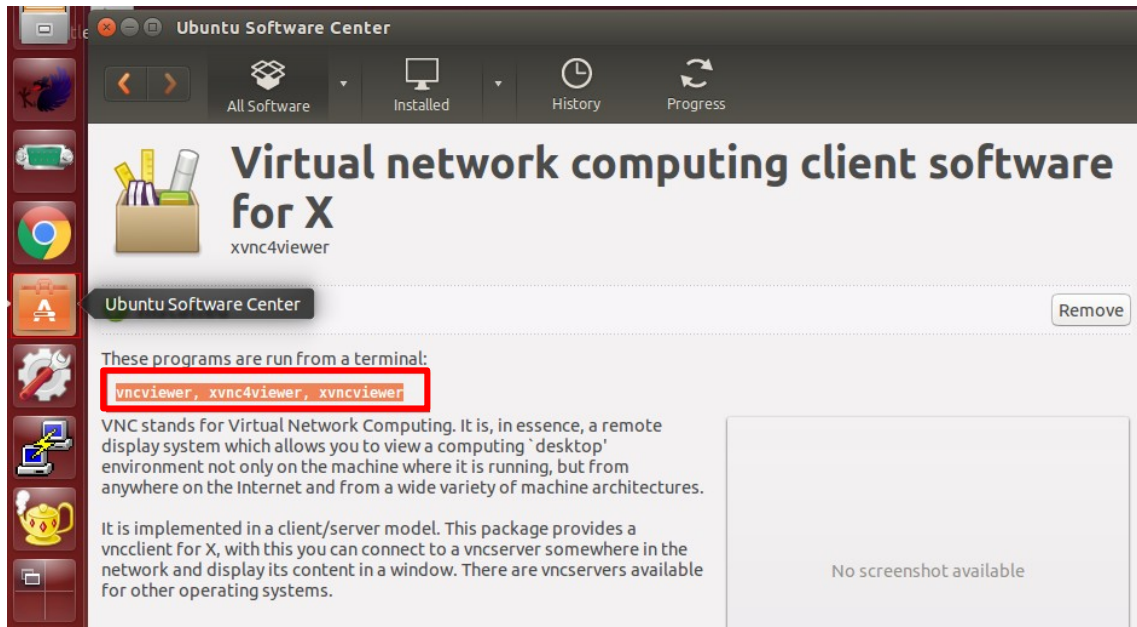

- 2.) Run VNC server on FLEETPC-ARM-300. You can click X11VNC icon on Yocto desktop or type the following command on Yocto console: `/usr/bin/x11vnc -display :0` (default TCP/IP port : 5900)

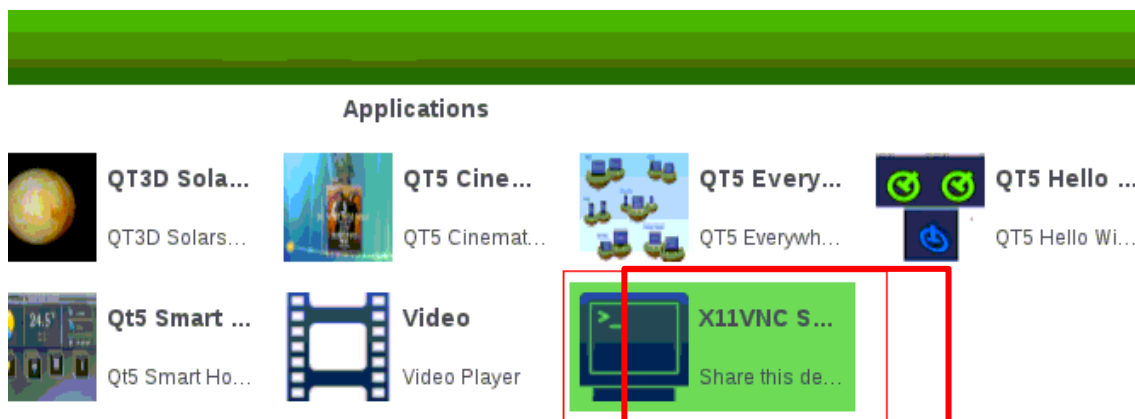

- 3.) Run xvnc4viewer on Ubuntu PC (default no password)



- 4.) Click "Create a new remote desktop file" → Enter Remote Desktop Profile as in the diagram below, and click "Connect" button.

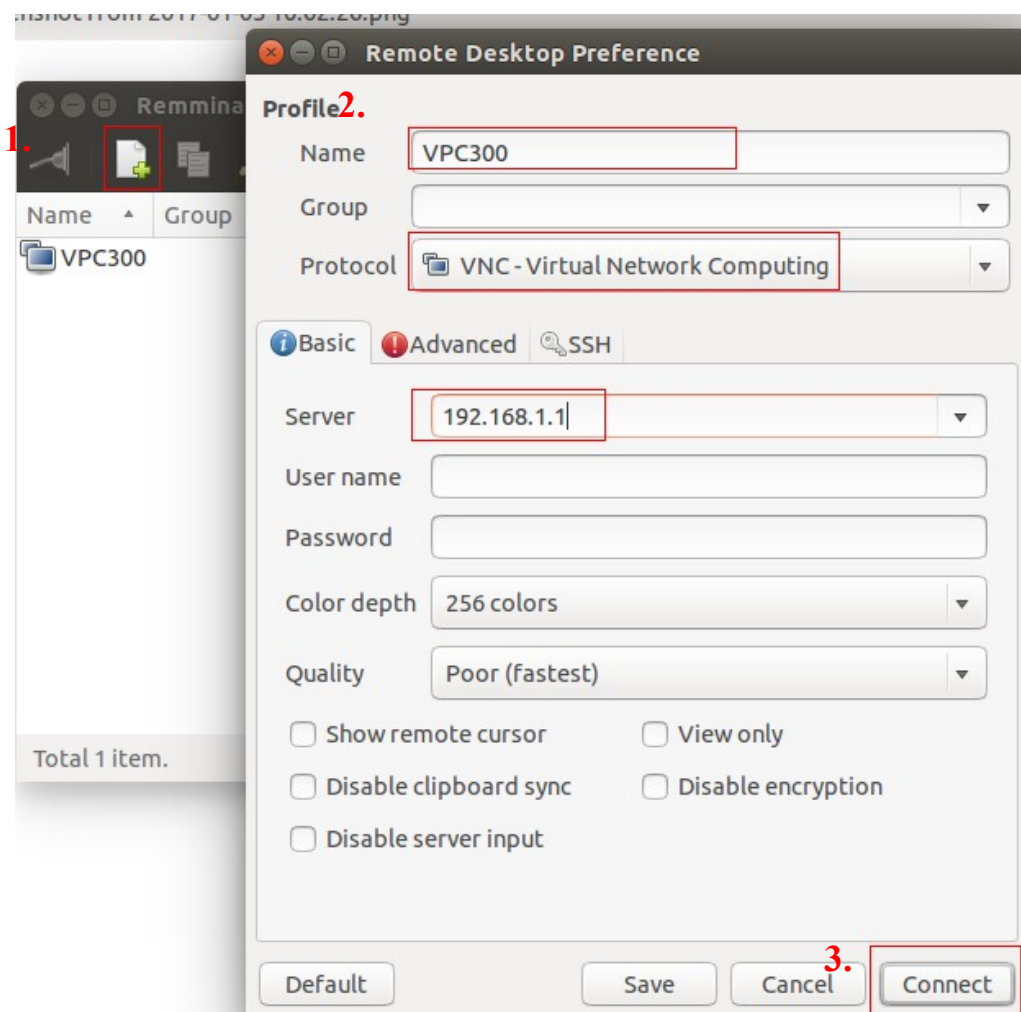

5.) Once the connection is successful, you will see FLEETPC-ARM-300 desktop on Ubuntu.



D-2 Access FLEETPC-ARM-300 from a remote Windows PC

1.) Download Real VNC software in Windows PC and install it.

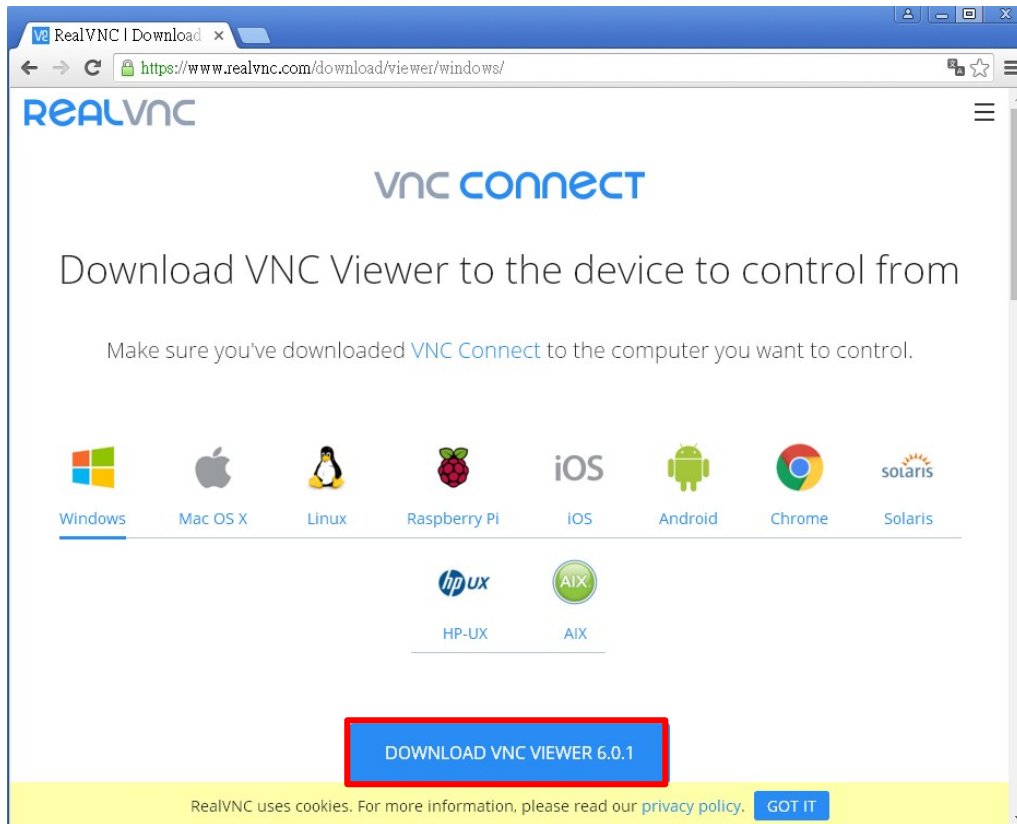

2.) Click VNC-Viewer to run it.



VNC-Viewer-6.0...

3.) In VNC Viewer screen, click File → New Connection to enter new connection property.

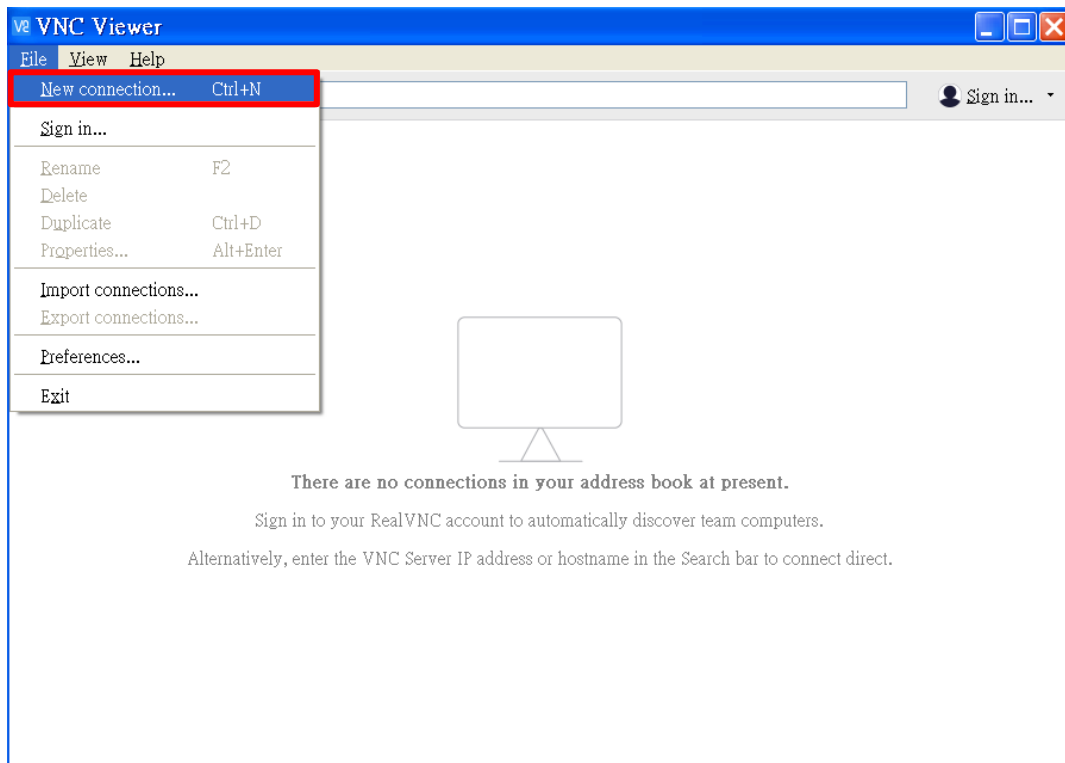

- 4.) Enter below connection property and click OK :
- VNC Server : 192.168.1.1:5900 (default TCP/IP port is 5900)
- Name : FLEETPC-ARM-300

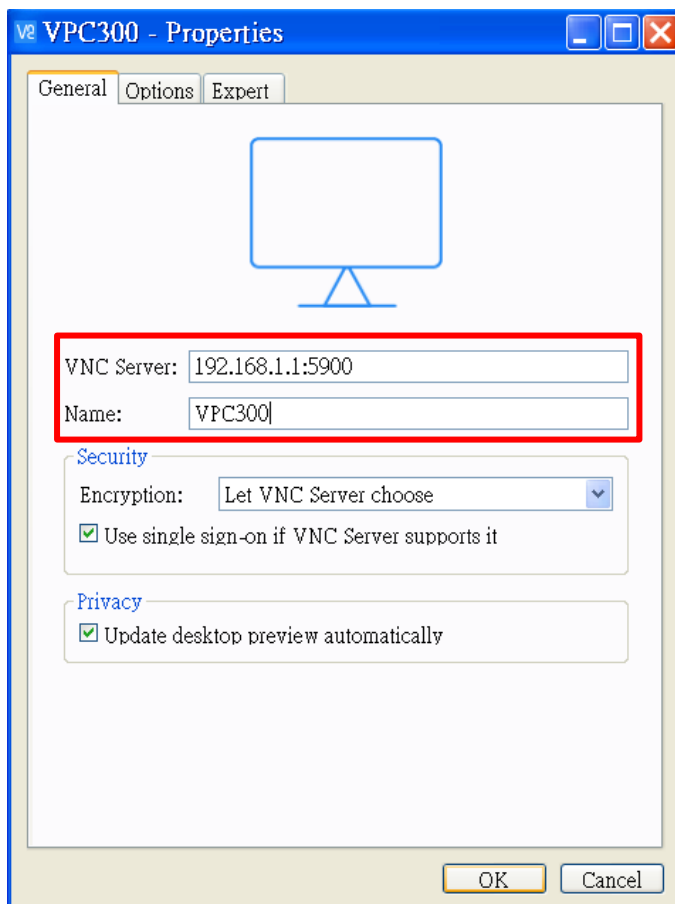

A new VNC connection is created.

- 5.) Run VNC server on FLEETPC-ARM-300. You can click X11VNC icon on Yocto desktop or type the following command on Yocto console: `/usr/bin/x11vnc -display :0` (default TCP/IP port : 5900)

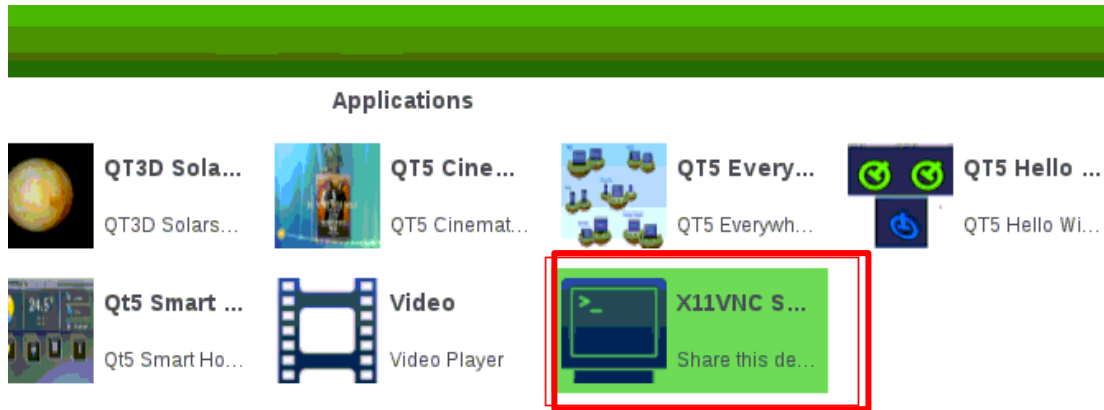

- 6.) Once the VNC connection is successful, you will see FLEETPC-ARM-300 desktop on Windows.